



EPSON Stylus COLOR 640
Manual

Copyright Notice

All rights reserved. No part of this publication may be reproduced, stored in a retrieval system, or transmitted in any form or by any means, electronic, mechanical, photocopying, recording, or otherwise, without the prior written permission of SEIKO EPSON CORPORATION. The information contained herein is designed only for use with this EPSON printer. EPSON is not responsible for any use of this information as applied to other printers.

Neither SEIKO EPSON CORPORATION nor its affiliates shall be liable to the purchaser of this product or third parties for damages, losses, costs, or expenses incurred by purchaser or third parties as a result of: accident, misuse, or abuse of this product or unauthorized modifications, repairs, or alterations to this product, or (excluding the U.S.) failure to strictly comply with SEIKO EPSON CORPORATION's operating and maintenance instructions.

SEIKO EPSON CORPORATION shall not be liable for any damages or problems arising from the use of any options or any consumable products other than those designated as Original EPSON Products or EPSON Approved Products by SEIKO EPSON CORPORATION.

EPSON, EPSON Stylus, and ESC/P are registered trademarks and Micro Piezo and ESC/P Raster are trademarks of SEIKO EPSON CORPORATION.

SoundAdvice is a service mark and PhotoEnhance and EPSON FaxAdvice are trademarks of Epson America, Inc.

General Notice: Other product names used herein are for identification purposes only and may be trademarks of their respective owners. EPSON disclaims any and all rights in those marks.

The ENERGY STAR emblem does not represent EPA endorsement of any product or service.

Copyright © 1998 by Epson America, Inc.

ESC6400698

6/98

Contents

<i>Introduction</i>	8
Windows System Requirements	9
How To Use Your Documentation	10
Warnings, Cautions, Notes, and Tips	11
ENERGY STAR Compliance	11
Year 2000 Ready	12
Important Safety Instructions	12
<i>Basic Printing</i>	15
Setting Printer Options from Windows Applications	16
Setting Default Printer Options	20
Windows 95, Windows 98, or Windows NT 4.0	20
Windows 3.1	22
Checking Print Job Status	23
Windows 95, Windows 98, and Windows NT 4.0	23
Windows 3.1	24

<i>Advanced Printing</i>	25
Using Custom Project Types	26
Customizing Print Quality and Special Effects	29
Adjusting Color Settings	32
Using PhotoEnhance3 or Digital Camera Correction Mode	33
Using Custom Color Management Modes	35
Using a Color Correction System	38
Selecting Paper Size and Orientation Options	39
Selecting Print Layout Options	46
Reducing and Enlarging Your Document Size	47
Using Multiple Print Layouts and Page Frames	51
Adding a Watermark	52
Saving Custom Settings	57
Redefining Custom Settings	59
Deleting Custom Settings	60

<i>Printing on Special Media</i>	61
Selecting Special Media	62
Media Loading and Handling Guidelines	64
Letterhead, Preprinted Forms, and Legal-size Paper	66
Envelopes	67
EPSON Photo Quality Ink Jet and Note Cards	68
EPSON Ink Jet Paper	68
EPSON Photo Quality Glossy Film	69
EPSON Photo Quality Glossy Paper	70
EPSON Photo Paper	70
EPSON Ink Jet Transparencies	74
EPSON Photo Stickers	74
EPSON Photo Quality Self Adhesive Sheets	74
EPSON Iron-On and Iron-On Cool Peel Transfer Paper	75
<i>Managing Print Jobs</i>	76
Managing Print Jobs in Windows 95, Windows 98, and Windows NT 4.0	77
Selecting the Speed & Progress Options	78
Using the Spool Manager	81
Using Status Monitor 2	82

Managing Print Jobs in Windows 3.1	92
Using the Spool Manager	92
Network Printing in Windows 95 and Windows 98	95
Setting Up the Host System for Printer Sharing	96
Setting Up Client Systems to Share the Printer	97
<i>Maintenance and Transportation</i>	98
Cleaning the Print Head	99
Using the Head Cleaning Utility	100
Using the Printer Control Panel	102
Examining the Nozzle Check Pattern	103
Replacing an Ink Cartridge	104
Removing an Empty Ink Cartridge	105
Installing the New Cartridge	106
Replacing an Outdated Ink Cartridge	108
Aligning the Print Head	110
Cleaning the Printer	111
Transporting the Printer	112

<i>Troubleshooting</i>	113
Identifying Printer Parts	114
Diagnosing Problems	115
Checking the Control Panel Lights	116
Running a Printer Check	118
Improving Print Quality	119
Solving Printing Problems	126
Solving Printer Software Problems	130
Fixing Paper Problems	134
Solving Miscellaneous Printout Problems	137
Uninstalling Printer Software	140
Windows 95, Windows 98, and Windows NT 4.0 Instructions	140
Windows 3.1 Instructions	141
Where To Get Help	142
<i>Specifications</i>	144
<i>Glossary</i>	155
<i>Index</i>	160

Introduction

Your EPSON Stylus® COLOR 640 printer is the ideal output device for business graphics, presentations, digital photography—or any project you create on your computer. With resolutions up to 1440 by 720 dpi and EPSON's Micro Piezo™ technology, you get amazingly realistic photographic images, vivid color graphics, and razor-sharp black text.

EPSON's specially formulated ink cartridges and wide variety of ink jet papers offer the most flexibility for getting the results you want.

This chapter gives you general information about your printer in these sections:

- ▶ [Windows System Requirements](#)
- ▶ [How To Use Your Documentation](#)
- ▶ [ENERGY STAR Compliance](#)
- ▶ [Year 2000 Ready](#)
- ▶ [Important Safety Instructions](#)

Windows System Requirements

To use your printer and its software with a PC, your system should have:

- ▶ Windows® 3.1x, Windows 95, Windows 98, or Windows NT® 4.0
- ▶ An IBM® compatible PC with at least a 486/25 MHz processor for Windows 95 and Windows NT 4.0; 486/66 MHz processor for Windows 98; and 386/25 MHz processor for Windows 3.1. A Pentium® processor or its equivalent is recommended.
- ▶ 16MB RAM (32MB for Windows 95 or 98, or 64MB for Windows NT 4.0 recommended)
- ▶ At least 50MB of free hard disk space for storing images (100MB recommended)
- ▶ VGA or better display adapter and monitor
- ▶ Double-speed CD-ROM drive (quad-speed or faster recommended)
- ▶ A shielded, twisted-pair parallel printer cable (6 to 10 feet long) to connect your computer to the printer. The cable must have a D-SUB, 25-pin, male connector for your computer and a 36-pin, Centronics® compatible connector for the printer.

How To Use Your Documentation

To set up your printer and install the printer software, see the *Start Here* card. The *Printer Basics* book contains printing instructions, details about the software on the CD-ROM, and installation instructions. This manual contains the following information:

[Basic Printing](#) covers the basics—selecting printer options and checking print job status.

[Advanced Printing](#) tells you how to print using custom settings for print quality, color management, and distinctive layouts.

[Printing on Special Media](#) gives guidelines for selecting the right paper or other media for your print job and instructions for loading it in your printer.

[Managing Print Jobs](#) explains how to control print jobs and check printer status while you're printing.

[Maintenance and Transportation](#) gives instructions for replacing ink cartridges, cleaning and aligning the print head, and cleaning and transporting the printer.

[Troubleshooting](#) provides solutions for any problems you may have with your printer or software.

[Specifications](#) provides the technical details on your printer, ink cartridges, and EPSON papers.

The [Glossary](#) gives definitions for terms that may be unfamiliar.

To go right to the section you need, see the [Index](#).

Warnings, Cautions, Notes, and Tips

You'll find this information throughout your manual:



Warnings must be followed carefully to avoid bodily injury.



Cautions must be observed to avoid damage to your equipment.



Notes contain important information about your printer.



Tips contain additional hints for great printing.



ENERGY STAR Compliance

As an ENERGY STAR Partner, EPSON has determined that this product meets the ENERGY STAR guidelines for energy efficiency.

The EPA ENERGY STAR Office Equipment program is a voluntary partnership with the computer and office equipment industry to promote the introduction of energy-efficient personal computers, monitors, printers, fax machines, and copiers in an effort to reduce air pollution caused by power generation.

Year 2000 Ready

Your EPSON printer is *Year 2000 Ready*. However, be sure the other parts of your computer system are also ready for the year 2000.

Important Safety Instructions

Before using your printer, read the following safety instructions to make sure you use the printer safely and effectively.

- ▶ Always use the  power button to turn the printer on or off. Never use an external switch—such as a power strip—to turn off the printer.
- ▶ Turn off and unplug the printer before cleaning. Clean with a damp cloth only. Do not spill liquid on the printer.
- ▶ Do not place the printer on an unstable surface or near a radiator or heating vent.
- ▶ Do not block or cover the openings in the printer's cabinet or insert objects through the slots.
- ▶ Use only the type of power source indicated on the printer's label.
- ▶ Connect all equipment to properly grounded power outlets. Avoid using outlets on the same circuit as photocopiers or air control systems that regularly switch on and off.

- ▶ Place the printer near a wall outlet where the plug can be easily unplugged.

Placez l'imprimante près d'une prise de contact où la fiche peut être débranchée facilement.

- ▶ Do not let the power cord become damaged or frayed.
- ▶ If you use an extension cord with the printer, make sure the total ampere rating of the devices plugged into the extension cord does not exceed the cord's ampere rating. Also, make sure the total of all devices plugged into the wall outlet does not exceed 15 amperes.
- ▶ Except as specifically explained in this *Manual*, do not attempt to service the printer yourself.

- ▶ Unplug the printer and refer servicing to qualified service personnel under the following conditions:

If the power cord or plug is damaged; if liquid has entered the printer; if the printer has been dropped or the cabinet damaged; if the printer does not operate normally or exhibits a distinct change in performance. Adjust only those controls that are covered by the operating instructions.

- ▶ Do not put your hand inside the printer or touch the cartridge during printing.
- ▶ Under normal circumstances, ink will not come out of the cartridge. If it does get on your skin, wash it off with soap and water. If it gets in your eyes, flush them immediately with water.

- ▶ Keep ink cartridges out of the reach of children.
- ▶ Do not dismantle the ink cartridges or try to refill them. This could result in damage to the print head.
- ▶ Once you install an ink cartridge, do not open the clamp or remove the cartridge except to replace it with a new one. The cartridge may become unusable otherwise.
- ▶ Install the ink cartridge immediately after you remove it from its foil package. Leaving the cartridge unpacked for a long time before use may result in reduced print quality.
- ▶ Do not use an ink cartridge beyond the date printed on the cartridge carton. For best results, use up the ink cartridges within six months of installing them.
- ▶ Do not shake an ink cartridge; this can cause leakage.
- ▶ Always turn the printer off using the ⏻ power button. When this button is pressed, the ⏻ power light flashes briefly then goes out. Do not unplug the printer or turn off the power to the outlet until the ⏻ power light is off.
- ▶ Before transporting the printer, make sure the print head is capped in the far right position and the ink cartridges are in place.

Basic Printing

It's easy to print with your new EPSON Stylus COLOR 640. First set up and install the printer software, following the instructions in the *Start Here* card. Then read this chapter to learn about:

- ▶ [Setting Printer Options from Windows Applications](#)
- ▶ [Setting Default Printer Options](#)
- ▶ [Checking Print Job Status](#)



Note:

The settings you select through your application usually apply only until you exit that application.

Setting Printer Options from Windows Applications

This section describes the settings you'll need to make for all your everyday printouts. See [Advanced Printing](#) for information about special settings like PhotoEnhance3 (PhotoEnhance™ in Windows 3.1).

- 1 Open your application and select a document to print.
- 2 From the File menu, click **Print**. You see a Print dialog box, similar to the one below.

Make sure your printer is selected here.

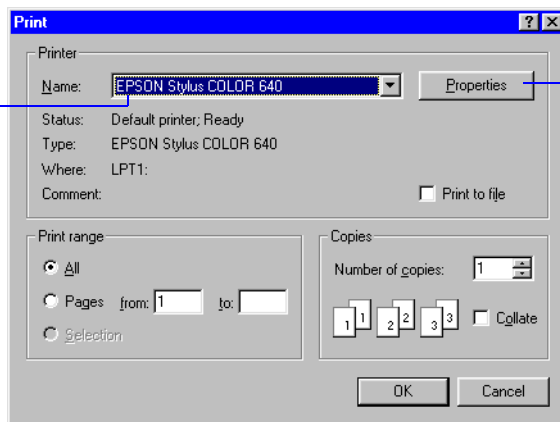

If you see a Properties button, click it.

If you see Setup, Printer, or Options, click that button instead.

- 3 Make sure your EPSON Stylus COLOR 640 printer is selected.

- 4 If your application's Print dialog box contains a **Properties** button, click it and go to step 5.

If you see a **Setup**, **Printer**, or **Options** button, click it. You see another dialog box that contains the **Properties** button. Click it and go to step 5. (In Windows 3.1, you won't see a Properties button; just click **Setup**, **Printer**, or **Options** until you see the window shown in step 5.)

- 5 You see the dialog box for your printer software. If necessary, click the **Main** tab to display the basic settings shown below.

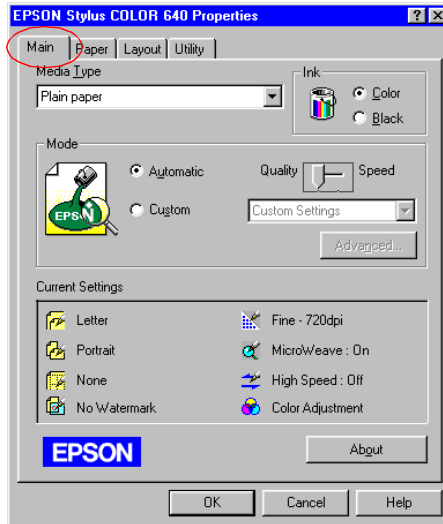

Windows 95, 98, NT

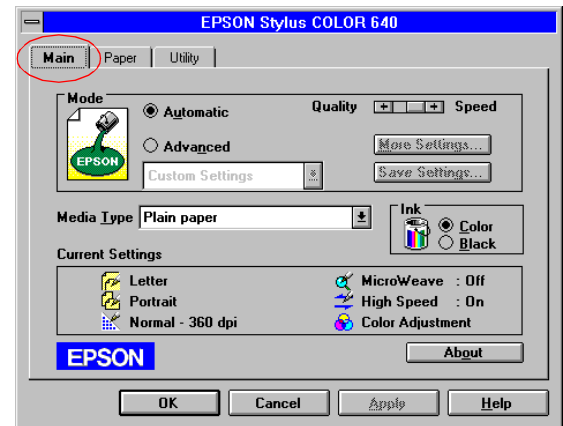

Windows 3.1



For more information about printer settings, click the Help button. You can right-click any item on the screen and then click What's This? (not available for Windows 3.1).

- 6 Choose the **Media Type** you want to print on from the following list (click the arrow button to scroll through the list).

Your media choice may restrict the availability of other settings such as print quality (resolution), so you should always make this setting first. If you are not sure which setting to select, see [Selecting Special Media](#).

- ▶ **Plain paper**
- ▶ **360 dpi Ink Jet Paper**
- ▶ **Photo Quality Ink Jet Paper**
- ▶ **Photo Paper**
- ▶ **Photo Quality Glossy Film**
- ▶ **Ink Jet Transparencies**

- 7 For the Ink setting, choose **Color** or **Black**.
- 8 Make sure the Mode option is set to **Automatic**. This lets the printer software determine the best settings for your print job and is the easiest way to get good printing results on all types of paper.
- 9 Set the slider in the Mode box to **Quality** or **Speed**. This lets you choose between the highest resolution or the fastest printing for the media you're using. (The slider is not available when certain media types are selected.)

- 10 Click the **Paper** tab and choose your paper size, number of copies, orientation, and printable area. See [Selecting Paper Size and Orientation Options](#) for instructions.
- 11 Click the **Layout** tab (not available with Windows 3.1) and check the reduce/enlarge (proportional printing), print layout, and watermark options to make sure they're correct for your print job. See [Selecting Print Layout Options](#) for instructions.
- 12 Click **OK** when you're finished checking your settings. The dialog box closes.
- 13 Click **OK** or **Print** in your application's printing dialog box. You may need to click a sequence of these buttons, depending on the application you are using.

While your document is printing, the EPSON Progress Meter (EPSON Despooler in Windows 3.1) appears, showing the printing progress and the status of your printer. See [Checking Print Job Status](#) for more information.



Note:

Some application settings override default printer settings (such as Paper Size or Orientation), so it's a good idea to check the settings in your application before you print.

You can access the default Windows NT printer software settings only if you have the appropriate network access privileges, such as Administrator or Power User.

Setting Default Printer Options

When you change printer settings through your software application, the settings apply only to the application you're using. To adjust the default settings for **all** your Windows applications, you can access the dialog box through the Printers utility or the Control Panel (Windows 3.1).

Close all your software applications before you start. If you don't, you may have to close and then reopen them to have the new default settings take effect.

Windows 95, Windows 98, or Windows NT 4.0

- 1 Click **Start**, point to **Settings**, and then select **Printers**.
- 2 Right-click the **EPSON Stylus COLOR 640** icon.

- 3 Select **Properties (Document Defaults in Windows NT)**. Then click the **Main** tab.

You see the printer settings dialog box, as shown below. Any changes you make will become the default settings for all your applications and documents. Click **OK** when you're finished.

These tabs are available only when Properties is accessed as described in this section. They are not available when Properties is accessed from within your application.

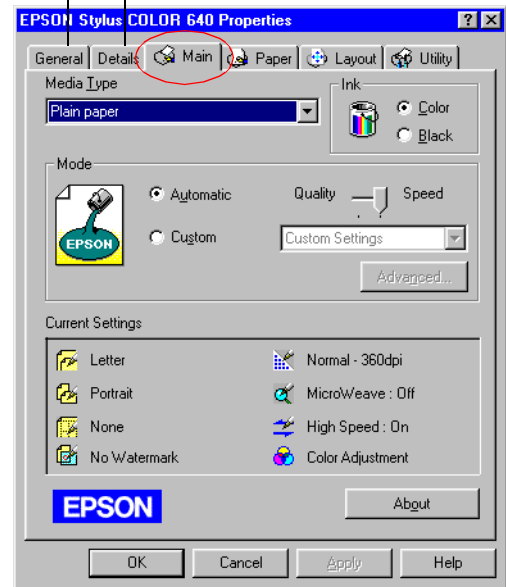

Windows 3.1

- 1 Double-click the **Control Panel** icon in the Main group.
- 2 Double-click the **Print Manager** icon.
- 3 Select **Printer Setup** from the Options menu.
- 4 Make sure **EPSON Stylus COLOR 640** is selected, then click **Setup**. You see the printer settings dialog box, shown below.



- 5 Make any changes you want to become the default settings for all your applications and documents, and click **OK** when you're finished.

Checking Print Job Status

While your document is printing, your printer software reports how the job is doing. See the section for your operating system below.

Windows 95, Windows 98, and Windows NT 4.0

After you send a print job in Windows 95, 98, or NT, the Progress Meter dialog box appears on your screen:

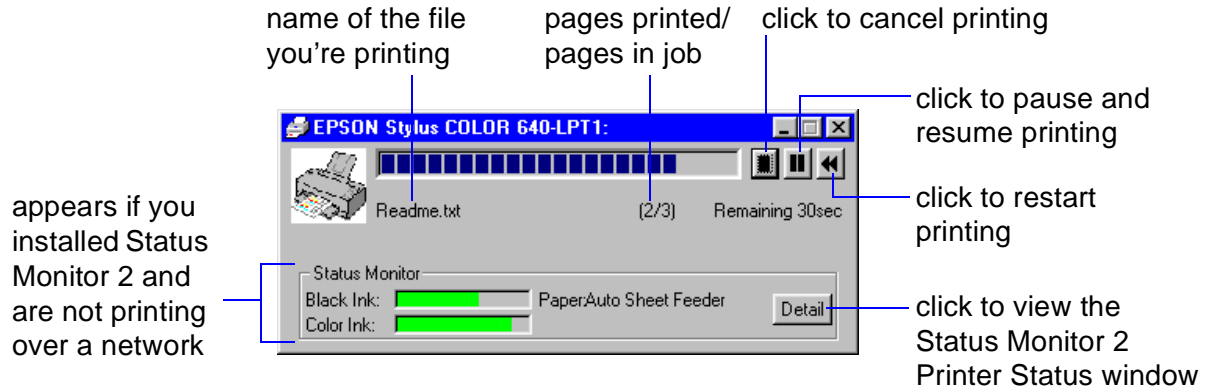

The Progress Meter shows the progress of your print job and the status of your printer. You can use the buttons to cancel, pause, or restart your print job. You can select whether to display the Progress Meter dialog box or not; see [Selecting the Speed & Progress Options](#). If you installed Status Monitor 2, you also see

information about how much ink you have left and can view the Status Monitor 2 Printer Status window (see [Using Status Monitor 2](#)).

Windows 3.1

After you send your print job, the EPSON Despooler dialog box appears on your screen:



This dialog box shows the progress of your print job and the status of your printer. If you run out of paper while printing, for example, the Despooler warns you. You can use the buttons to cancel, pause, or restart/requeue your print job.

You can also control print jobs using the Spool Manager; see [Using the Spool Manager](#) for more information.

Advanced Printing

When your photographs, reports, or other projects have special printing requirements, you can use the custom settings in your EPSON Stylus COLOR 640 software. You can choose predefined custom project types or adjust individual options like brightness, contrast, sharpness, and halftoning. For professional-quality color accuracy, you can use a color matching mode.

Your printer software's print layout options let you print almost any size image on your printer, proof multiple pages on one sheet of paper, and add watermarks (not available with Windows 3.1).

This chapter includes the following information:

- ▶ [Using Custom Project Types](#)
- ▶ [Customizing Print Quality and Special Effects](#)
- ▶ [Adjusting Color Settings](#)
- ▶ [Selecting Paper Size and Orientation Options](#)
- ▶ [Selecting Print Layout Options](#)
- ▶ [Saving Custom Settings](#)

Using Custom Project Types

The printer software includes predefined custom project types that provide an easy way to fine-tune your printer settings for a specific type of project. Follow these steps to print with custom project types:

- 1 Create your image or document in your application software.
- 2 Access the printer settings dialog box as described in [Setting Printer Options from Windows Applications](#). You see one of the following dialog boxes:

Click **Custom**, then click here to see a list of project types.

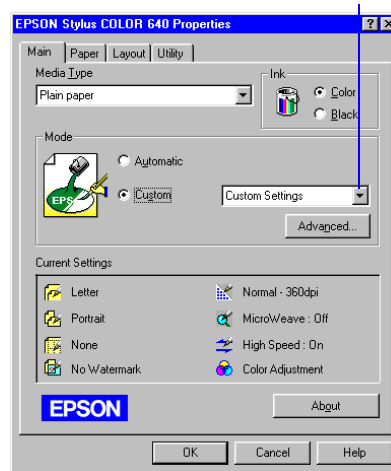

Windows 95, 98, NT

Click **Advanced**, then click here to see a list of project types.

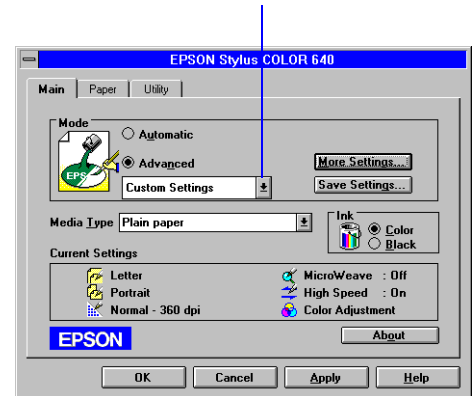

Windows 3.1



Note:

Always choose your Media Type and Ink setting before you select a project from the Custom Settings list. Some project types may not be available with the Media or Ink setting you choose.

Printing with PhotoEnhance3 or PhotoEnhance may take longer, depending on your computer and image.

- 3 Choose the **Media Type** you want to print on. (If you're not sure which setting to select, see [Selecting Special Media](#).)
- 4 Choose **Color** or **Black** ink.
- 5 Click **Custom**, and then click **Custom Settings** (in Windows 3.1, click **Advanced**, then click **Custom Settings**). You see the list of project types.
- 6 Choose the right setting for your project and Media Type following these guidelines:
 - ▶ **PhotoEnhance3 (PhotoEnhance** in Windows 3.1)
For printing images captured using a video camera or scanner (or digital camera in Windows 3.1). Produces sharper images and more vivid colors by automatically adjusting the contrast, saturation, and brightness. Corrects for overall under- and over-exposure of the original image.
 - ▶ **Digital Camera** (not available with Windows 3.1)
For printing images taken with a digital camera or scanner. Corrects "noise" or other common flaws.
 - ▶ **Text/Graph**
For printing graphics-intensive documents like presentation pages with charts and graphs. Intensifies colors and lightens the midtones and highlights.
 - ▶ **Economy**
For rough drafts of text only. Saves ink.

- ▶ **ICM** (Image Color Matching; Windows 95 and 98 only)
For printing documents created in an ICM compatible application. If you're using an ICM compatible monitor, adjusts printed colors to closely match the screen colors.
 - ▶ **sRGB** (Standard Red Green Blue; not available with Windows 3.1, recommended for use with Windows 98 only)
For printing documents created in an sRGB compatible application using sRGB colors, such as those designed for the World Wide Web. First set up your sRGB compatible devices (such as your monitor and printer) to use an sRGB color profile; see your Windows 98 online help for details.
- 7 Click the **Paper** tab and **Layout** tab (not available on Windows 3.1) to check or change any necessary settings, as described in [Selecting Paper Size and Orientation Options](#) and [Selecting Print Layout Options](#).
 - 8 Click **OK** when you're finished checking your settings. The dialog box closes.
 - 9 Click **OK** or **Print** in your application's printing dialog box. You may need to click a sequence of these buttons, depending on the application you are using.



After you customize your print settings for a special project, you can save them as a group. Then you can reuse them whenever you print a similar project. See [Saving Custom Settings](#).

Customizing Print Quality and Special Effects

Your printer software automatically selects the best settings for the Media Type you choose. However, you can adjust individual settings for more fine-tuning or experimenting with special effects.

- 1 Create your image or document in your application software.
- 2 Access the printer settings dialog box as described in [Setting Printer Options from Windows Applications](#).
- 3 Click **Custom**, and then click the **Advanced** button. (In Windows 3.1, click **Advanced**, then click **More Settings**.)

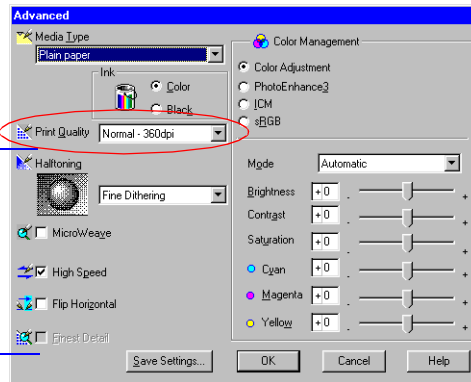

Windows 95, 98, NT

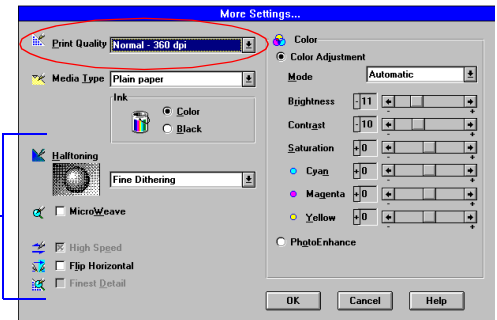

Windows 3.1

Some of these options are automatically set or disabled by other settings you choose



Note:

The available Print Quality settings may be limited by the Media Type you choose.

In Automatic mode, the Halftoning setting is selected based on the data in your print job.

In Custom mode, Halftoning is preselected for each project type to give you the best printout.

No Halftoning is available only when you select Black as the Ink setting.

- 4 Choose the **Media Type** and **Ink** settings you want to use. (If you're not sure which Media Type to select, see [Selecting Special Media](#).)
- 5 Choose one of the following **Print Quality** options:
 - ▶ **Economy**
For low-resolution rough drafts on plain paper. Saves ink.
 - ▶ **Normal - 360 dpi**
For most documents on plain paper, transparencies, or 360 dpi Ink Jet Paper.
 - ▶ **Fine - 720 dpi**
For high-resolution output on plain paper, Photo Paper, or Photo Quality Ink Jet Paper.
 - ▶ **SuperFine - 1440 dpi**
For the highest-resolution output on Photo Paper or Photo Quality media.
- 6 Choose one of the following **Halftoning** options:
 - ▶ **No Halftoning**
For printing black text only.
 - ▶ **Error Diffusion**
For printing photographic or video/digital camera images. Blends each color dot with the dots around it.
 - ▶ **Fine Dithering**
For printing graphs or other images that require precise, solid areas of bright colors.



If vertical lines in your printout are misaligned when you use the High Speed setting, you may need to turn off this setting or align the print heads. See [Aligning the Print Head](#) for instructions.

- 7 Choose any of the following print options.
 - ▶ **MicroWeave**
For improved print quality. Prints graphic data in finer increments to eliminate unwanted banding effects (light horizontal lines). Always use for color printing.
 - ▶ **High Speed**
For fast, bidirectional printing at lower resolution.
 - ▶ **Flip Horizontal**
Prints a mirror image of your document. Use with iron-on transfer paper so your ironed-on printout will read correctly.
 - ▶ **Finest Detail**
For printing text, graphics, and line art with very sharp edges. Slows print speed and increases your system memory requirements.
- 8 Click **OK** if you're ready to return to the printer settings dialog box, or see [Adjusting Color Settings](#) if you want to adjust your document's color settings.

Adjusting Color Settings



Before adjusting the colors in a photograph, try printing on better quality paper. Colors always appear truer on photo quality paper than on plain paper. See the media pack that came with your printer for paper samples.

Generally, you don't need to adjust color settings since the printer software automatically detects the appropriate settings for your Media Type and project (see [Using Custom Project Types](#)). However, if you want to experiment with color, your printer software provides a range of options:

- ▶ [Using PhotoEnhance3 or Digital Camera Correction Mode](#) to automatically correct digital photographs for exposure and other common flaws, and to adjust the tone or sharpness.
- ▶ [Using Custom Color Management Modes](#) to select individual color values to fine-tune the color in text, graphics, or economy mode documents.
- ▶ [Using a Color Correction System](#) for maximum color accuracy (not available with Windows 3.1).

The appearance of the Color Management section of the Advanced dialog box changes, depending on the settings you've selected.

Using PhotoEnhance3 or Digital Camera Correction Mode

To correct the exposure, tone, and sharpness of digital images, you can use PhotoEnhance3 (PhotoEnhance on Windows 3.1) and/or Digital Camera Correction mode (not available with Windows 3.1).

- 1 Create your image or document in your application software.
- 2 Access the printer settings dialog box as described in [Setting Printer Options from Windows Applications](#).
- 3 Click **Custom**, then select either **PhotoEnhance3** or **Digital Camera** in the Custom Settings list. (In Windows 3.1, click **Advanced**, then select **PhotoEnhance**.)



Note:
If your Color Management section looks different, click PhotoEnhance3 to get this view.

- Click the **Advanced** button. (In Windows 3.1, click **More Settings**.) The Advanced dialog box appears (only the Color Management section is shown below):

Click to select a Tone setting, if necessary. Changes are shown in the example photograph.

Click to turn on Digital Camera Correction mode and/or sharpen the image.

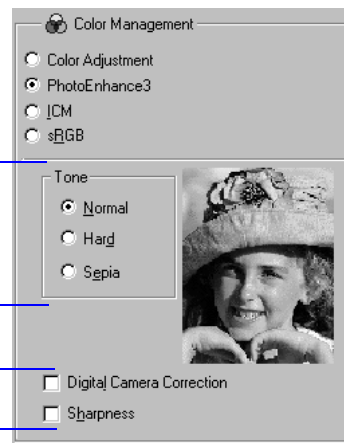

Windows 95, 98, NT only

- Customize your image using these settings (some settings may be preselected, depending on what was selected in step 3):
 - Select a Tone setting: **Normal** for standard tones, **Hard** for high contrast, or **Sepia** for an old-fashioned photo look
 - Turn on **Digital Camera Correction** to correct noise or other flaws common to digital camera images
 - Select **Sharpness** to sharpen the image, especially the edges.
- Click **OK** to return to the printer settings dialog box.

Using Custom Color Management Modes

You can choose from several custom Color Management modes or manually adjust brightness, contrast, saturation, and CMY (cyan, magenta, yellow) color values.

- 1 Create your image or document in your application software.
- 2 Access the printer settings dialog box as described in [Setting Printer Options from Windows Applications](#).
- 3 Click **Custom**, then click **Advanced** (in Windows 3.1, click **Advanced**, then **More Settings**). The Advanced dialog box appears (only the Color Management section is shown below):



Note:
If your Color Management section looks different, click Color Adjustment to get this view.

not available with
Windows 3.1;
ICM is not
available with
Windows NT 4.0

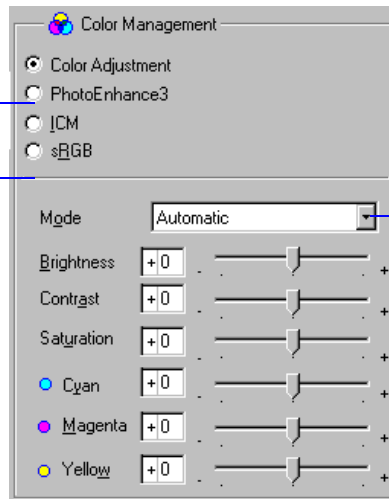

choose a color adjustment mode here

- 4 Choose one of the following **Color Adjustment Modes**:
- ▶ **Automatic**
Analyzes the color information in your project and optimizes color correction accordingly.
 - ▶ **Photo-realistic**
For printing color photographs.
 - ▶ **Vivid**
For printing graphics-intensive documents like presentation pages with charts and graphs. Intensifies colors and lightens the midtones and highlights.
 - ▶ **No Color Adjustment**
Disables the printer software's color adjustment features so you can use a stand-alone color management utility.

- 5 If you want to specify individual color correction values, use the sliders to increase (drag right) or decrease (drag left) the settings listed below.
 - ▶ **Brightness**
Makes your image lighter or darker.
 - ▶ **Contrast**
Increases or decreases the difference between the bright or dark parts of an image.
 - ▶ **Saturation**
Makes colors more vivid or less vivid.
 - ▶ **Cyan, Magenta, Yellow**
Increases or decreases the amount of the three ink colors that combine to make a full-color picture. Use these sliders to fine-tune the color balance in your printout.
- 6 Click **OK** to return to the printer settings dialog box.



Note:
These color correction options are not available on Windows 3.1.

Using a Color Correction System

To achieve the maximum color accuracy, you can use ICM (Image Color Matching; Windows 95 and 98 only) or sRGB (standard Red, Green, Blue; recommended for use with Windows 98 only), if your system supports these color correction systems.

- 1 Create your image or document in your application software.
- 2 Access the printer settings dialog box as described in [Setting Printer Options from Windows Applications](#).
- 3 Click **Custom**, then click **Advanced**. The Advanced dialog box appears (only the Color Management section is shown below):

not available with
Windows NT 4.0

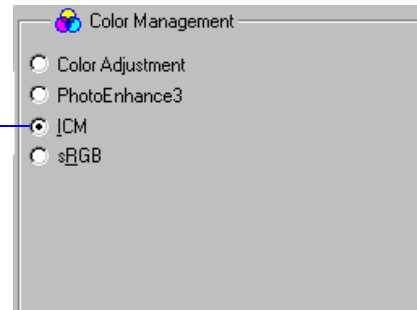

- 4 Select one of these color correction systems:
 - ▶ **ICM** (Image Color Matching; Windows 95 and 98 only)
For printing documents created in an ICM compatible application. If you're using an ICM compatible monitor, adjusts printed colors to closely match the screen colors.
 - ▶ **sRGB** (Standard Red Green Blue; not available with Windows 3.1; recommended for use with Windows 98 only)
For printing documents created in an sRGB compatible application using sRGB colors, such as those designed for the World Wide Web. First set up your sRGB compatible devices (such as your monitor and printer) to use an sRGB color profile; see your Windows 98 online help for details.
- 5 Click **OK** to return to the printer settings dialog box.

Selecting Paper Size and Orientation Options

Your printer can print on paper up to 9.5 inches wide and up to 44 inches long in either portrait or landscape orientation. If you print multi-page documents or multiple copies of documents, you can print the pages collated and in reverse order. You can even rotate the printed document by 180 degrees to make it closer to the bottom of the paper (not available with Windows 3.1).

- 1 Create your image or document in your application software.
- 2 Access the printer settings dialog box as described in [Setting Printer Options from Windows Applications](#).
- 3 Click the **Paper** tab. You see the Paper dialog box:

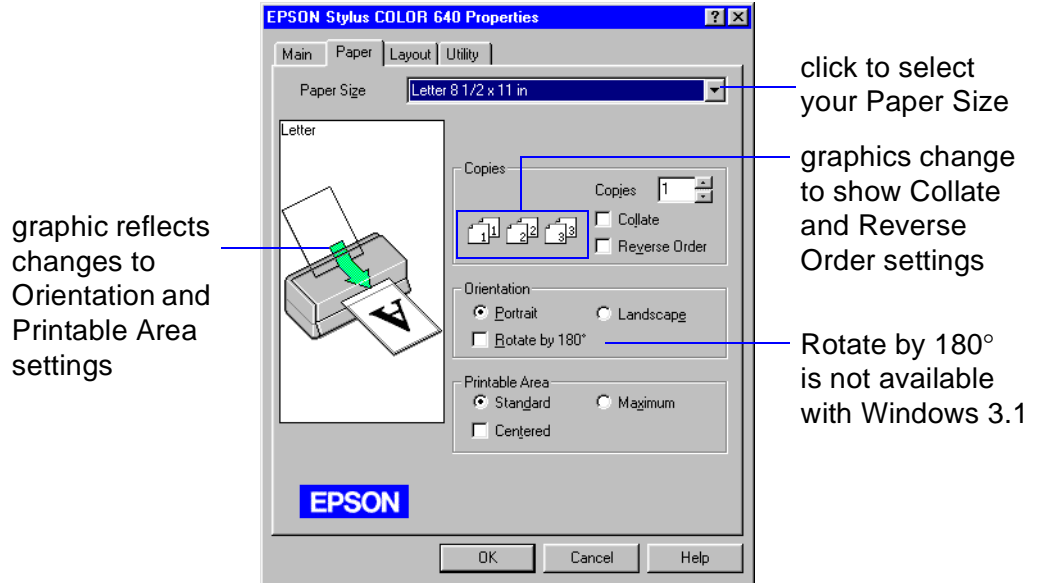



Note:

If the Reduce/Enlarge setting is set to Normal and you select one of the paper sizes that is marked with an asterisk (*), you see a dialog box asking you to select a paper size that fits your printer. See [Reducing and Enlarging Your Document Size](#) for more information.

- 4 Click the **Paper Size** drop-down list to select the size of paper you loaded in the printer.

The sizes marked with an asterisk (*) are not available with Windows 3.1. These sizes are larger than you can load in the printer and can be used only with the **Reduce/Enlarge** setting on the Layout tab; see [Reducing and Enlarging Your Document Size](#) for more information.

A4 210 × 297 mm

B5 182 × 257 mm

A5 148 × 210 mm

Letter 8 1/2 × 11 in

Legal 8 1/2 × 14 in

Executive 7 1/4 × 10 1/2 in

Half Letter 5 1/2 × 8 1/2 in

A6 Index card 105 × 148 mm

Index card 5 × 8 in

Index card 8 × 10 in

Envelope #10 4 1/8 × 9 1/2 in

Envelope DL 110 × 220 mm

Envelope C6 114 × 162 mm

Envelope 132 × 220 mm

Photo Paper 4 × 6 in

Panoramic 210 × 594 mm

B4 257 × 364 mm *

US B 11 × 17 in *

A3 297 × 420 mm *

Super A3/B 329 × 483 mm *

B3 364 × 514 mm *

A2 420 × 594 mm *

US C 17 × 22 in *

User Defined (See [Creating User Defined Paper Sizes](#) for instructions.)

- 5 If you did not or cannot select the number of copies you want to print in your application program's Print dialog box, choose the number (from 1 to 9999) in the **Copies** box. **If you select the number of copies here, you don't need to select the number of copies in your application's Print dialog box.**



Note:

The Rotate by 180° setting lets you print the lower portion of a document first, with a bottom margin as small as 0.12 inch (3 mm) and a top margin as small as 0.55 inch (14 mm). This option is not available with Windows 3.1.

- 6 If you're printing multiple copies of a multi-page document and you want the copies printed in sets, click the **Collate** checkbox.
- 7 If you're printing a multi-page document and want the last page printed first so the pages come out without needing to be reordered, click the **Reverse Order** checkbox.
- 8 Select the direction of printing on the page using the **Orientation** options. To print your document oriented as shown in one of the following printer graphics, select the options listed below it.

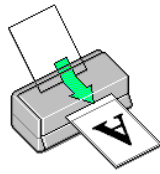

Portrait

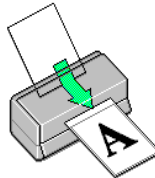

Portrait and
Rotate by 180°

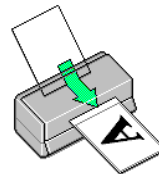

Landscape

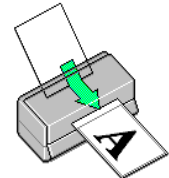

Landscape and
Rotate by 180°



Note:
When **Maximum** is selected, print quality may decrease in the expanded printable area.

- 9 The **Standard** Printable Area setting uses a minimum bottom margin of 0.55 inch (14 mm). If you want your printout to have a bottom margin as small as 0.12 inch (3 mm), set the Printable Area setting to **Maximum**. To center your document on the page using either setting, select the **Centered** checkbox.
- 10 Click a tab for the settings you want to check or change, or click **OK** when you're finished checking your settings. The dialog box closes.
- 11 Click **OK** or **Print** in your application's printing dialog box. You may need to click a sequence of these buttons, depending on the application you are using.

Creating User Defined Paper Sizes

You can create up to 10 custom paper sizes (one in Windows 3.1) and add them to the **Paper Size** list using the **User Defined** option. This is useful if you're printing a custom size document, such as a banner. You can select any width from 3.5 to 9.5 inches, and any height (length) from 3.5 to 44 inches.

Follow these steps to create a custom paper size with the **User Defined** option:

- 1 Follow the steps in [Setting Printer Options from Windows Applications](#) to access the printer software, then click the **Paper** tab. You see the Paper dialog box:

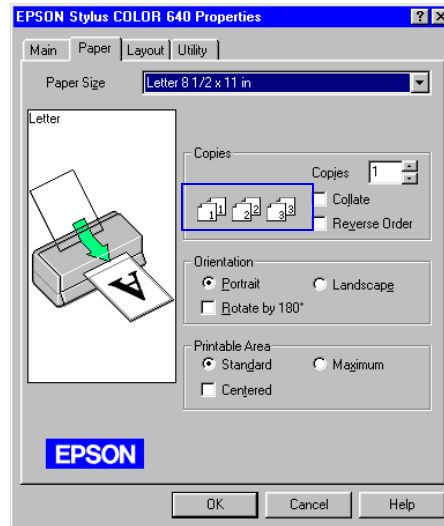

- 2 Click the **Paper Size** list and scroll to the bottom of it using the arrows or scroll bar.

- 3 Click the **User Defined** option. You see one of the following dialog boxes:

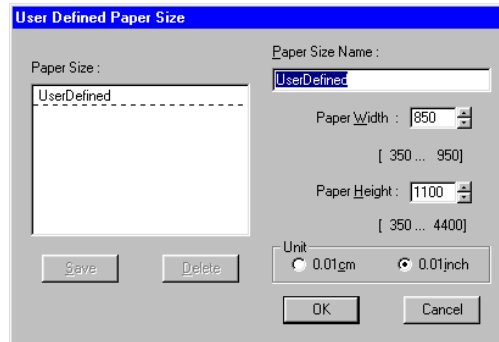

Windows 95, 98, NT

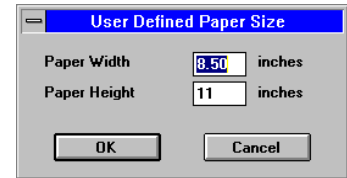

Windows 3.1



Note:

In Windows 95, 98, and NT, the Paper Width and Paper Height units are in hundredth of an inch (or centimeter) increments. For example, 850 equals 8.50 inches.

To use centimeters instead of inches, click the 0.01cm button.

- 4 **Windows 95, Windows 98, or Windows NT 4.0**

Type a name (up to 24 characters) for your custom paper size in the **Paper Size Name** field. Then select a **Paper Width** and **Paper Height**. When you're finished, click **Save**. The paper size name appears in the **Paper Size** list. Add more sizes if you want, and click **OK** when you're done.

Windows 3.1

You can create only one **User Defined** paper size. Type the width in the **Paper Width** field and the length in the **Paper Height** field. Then click **OK**.

You see the **Paper** tab again. The paper size name you defined is added to the **Paper Size** list and selected as the current setting. (In Windows 3.1, the setting is named **User Defined**.)

To change or delete a custom paper size:

- ▶ **Windows 95, Windows 98, or Windows NT**
Click **User Defined** in the Paper Size list. Then, on the User Defined Paper Size dialog box, select the custom paper name in the Paper Size list and change the **Paper Width**, **Paper Height**, and/or **Unit** settings as necessary, or click **Delete**. Click **OK** when you're done.
- ▶ **Windows 3.1**
You can change the custom paper size, but cannot delete it. Click **User Defined** in the Paper Size list. Then, on the User Defined Paper Size dialog box, change the **Paper Width** and **Paper Height** settings as necessary. Click **OK** when you're done.



Note:
Layout options are not available with Windows 3.1.

Selecting Print Layout Options

The print layout options let you reduce or enlarge almost any size document to print on your printer. You can also select options to proof multiple pages on one sheet of paper (with or without page frames) and add a predefined or custom watermark.

Follow the steps in these sections to use options on the Layout tab:

- ▶ [Reducing and Enlarging Your Document Size](#)
- ▶ [Using Multiple Print Layouts and Page Frames](#)
- ▶ [Adding a Watermark](#)

Reducing and Enlarging Your Document Size

When you want to make the printed size of a document different from its actual size, you can use your printer software's **Reduce/Enlarge** settings. You can make the document fit into the printable area on a selected paper size or you can choose to reduce or enlarge it to a selected percentage.

Follow these steps to reduce or enlarge your document size:

- 1 Follow the steps in [Setting Printer Options from Windows Applications](#) to access the printer software, then click the **Paper** tab.

- 2 Click the **Paper Size** list and select the actual size of the document you want to print.

For example, if your document size is 11 × 22 inches, select **US C 11 × 22 in**. This paper size is too large to fit in your printer, so you'll need to proportion it to fit on a **smaller** paper size (by **reducing** the document size). If your document size is 5 × 8 inches, but you want it to fit in the maximum area on Letter-size paper, you'll need to proportion it to fit on a **larger** paper size (by **enlarging** the document size).

- 3 If the **Paper Size** setting you selected for your document is **within** the maximum paper size that can fit on your printer, but you want to **enlarge or reduce** the document, you need to select the reduction/enlargement manually. Go to [step 5](#).

- 4 If the **Paper Size** setting you selected is **larger** than the maximum size that can be printed on your printer, you see this dialog box:

In the **Output Paper** list, select the actual size of the paper loaded in the printer and click **OK**. This automatically turns on the **Fit to Page** setting so your document fits into the printable area on the output paper.

The selected **Paper Size**, reduction percentage, and **Output Paper** settings now appear on the printer graphic. If you want to adjust the proportions or sizes, go to [step 5](#). If you're ready to print, go to [step 7](#).

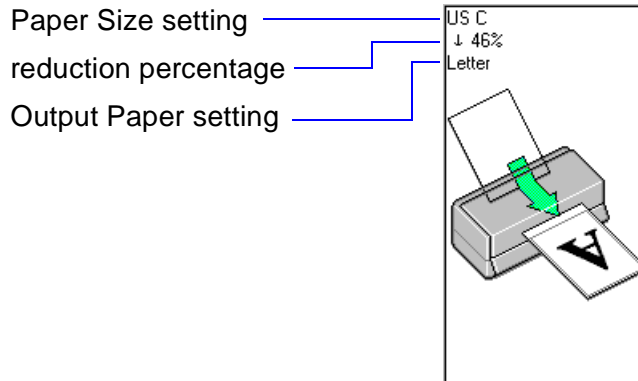
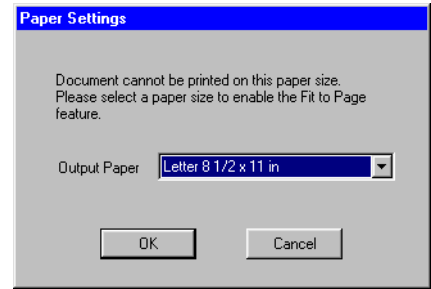

5 Click the **Layout** tab. You see the Layout dialog box:

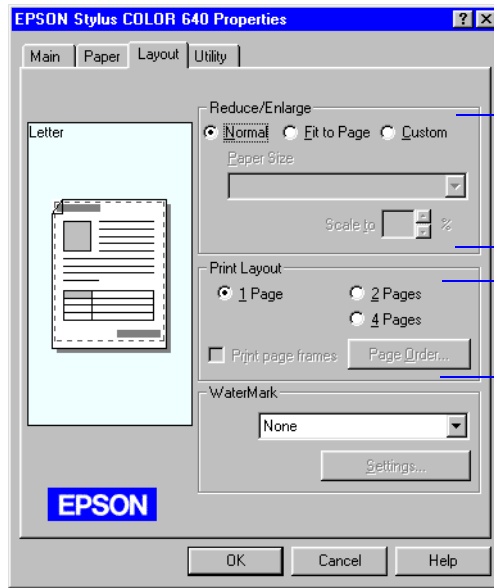

Reduce/Enlarge
(proportional
printing) settings

not available with
Windows 3.1



Note:
If you previously selected a Paper Size setting that is larger than the maximum paper size for your printer and then choose Normal, the Paper Size changes to Letter 8 1/2 x 11 in.

- 6 Select one of the following **Reduce/Enlarge** settings:
 - ▶ Select **Normal** to set the print proportion to 100%. This keeps your printout the same size as the original image.
 - ▶ Select **Fit to Page** to automatically reduce or enlarge the document to fit on the paper size loaded in the printer. The **Paper Size** option beneath the **Fit to Page** setting becomes active; select the size of paper loaded in the printer.

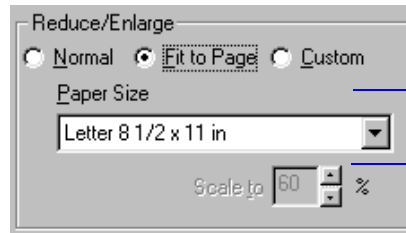

Select Fit to Page, then select the size of paper loaded in the printer here

- ▶ Select **Custom**, then select a percentage (10% to 400%) in the **Scale to:** field to reduce or enlarge the document by a specific amount.
- 7 If you're finished selecting Layout options, click **OK**.
If you want to select more options, see [Using Multiple Print Layouts and Page Frames](#).

Using Multiple Print Layouts and Page Frames

If you're printing a multiple page document, but you want a quick proof of each page printed on one piece of paper, you can use the Print Layout options. You can choose the way the pages are placed on the paper and add a lined frame to each page. (This option is not available in Windows 3.1.)

Follow these steps to use the Print Layout options:

- 1 Follow the steps in [Setting Printer Options from Windows Applications](#) to access the printer software, then click the **Layout** tab.
- 2 To print multiple pages of your document on one sheet of paper, select either the **2 Pages** or **4 Pages** radio button.

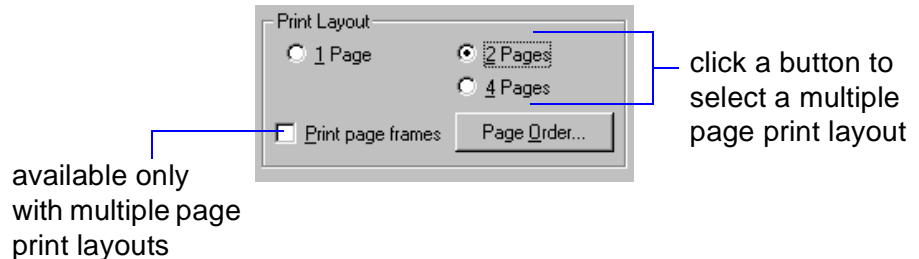

- 3 If the page order of the layout shown in the on-screen graphic is how you want your document printed, go to step 3.

To change the page order, click the **Page Order** button. Then select the page order you want to use from the Print Layout dialog box that appears.

- 4 If you want to frame each page's contents with a thin black line, click the **Print page frames** checkbox.
- 5 If you're finished selecting Layout options, click **OK**. If you want to select more options, see [Adding a Watermark](#).

Adding a Watermark

You can add a watermark to each page in your document to emphasize its purpose or indicate how the document should be handled. For example, you may want to add a watermark of the word "Confidential" to documents you don't want distributed to other people. Or you can add a custom bitmap of your company logo so your document looks like printed letterhead. (This option is not available in Windows 3.1.)



Note:
To add a custom watermark, you must first create the watermark as a bitmap in an application that can create bitmap files. See your application's documentation for instructions.

If you selected a multiple page print layout option as described in [Using Multiple Print Layouts and Page Frames](#), your watermark appears on each page in the layout.

Follow these steps to add a watermark:

- 1 Follow the steps in [Setting Printer Options from Windows Applications](#) to access the printer software, then click the **Layout** tab.
- 2 To select a watermark, click in the **WaterMark** drop-down list.

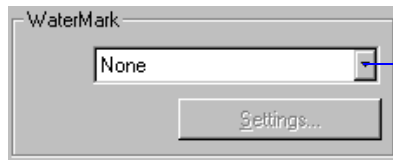

WaterMark
drop-down list

Then highlight one of the following predefined watermarks:

Confidential
Draft
Urgent
Priority
Hot

Do Not Copy
For Your Eyes Only
Review Copy
Top Secret
Duplicate

To turn off your watermark, select **None** from the drop-down list.

- 3 To change the watermark or specify how it appears, click the **Settings** button. You see the following dialog box:

See how your selections will look in the graphic shown here

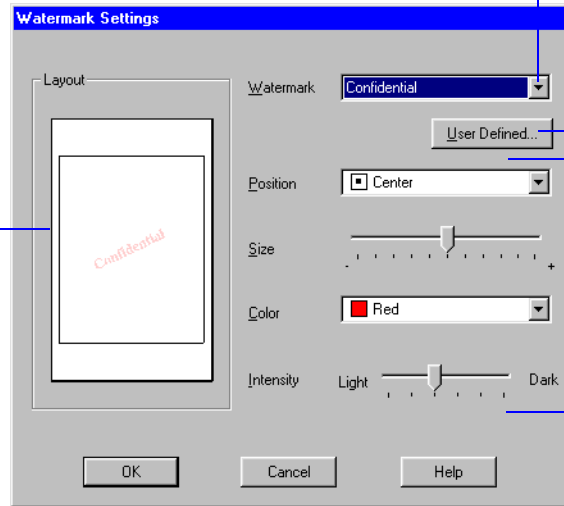

Click here to select a predefined watermark

Click here to load a custom watermark you've created

Specify how you want your watermark to appear using these options



Note:

You can create up to 10 custom watermarks. In Windows 95 and Windows 98, you can use any bitmap file up to 15MB in size. With Windows NT, the file can be any size.

To delete a custom watermark you've added to the list, click the User Defined button. Then select the watermark and click Delete. Click OK to close the dialog box.

- 4 To load a custom watermark you've created as a bitmap in an application program, click the **User Defined** button. You see the following dialog box:

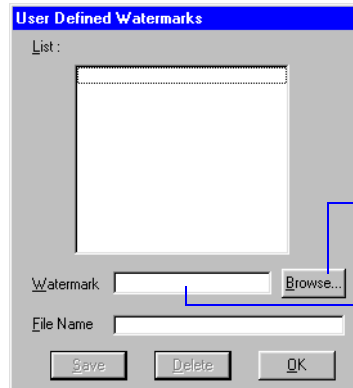

Click Browse to select your bitmap file

Then type a name for your custom watermark here and click Save

Click the **Browse** button. You see a file selection dialog box. Navigate to the folder containing the bitmap file you want to use, select the file, and click **OK**.

Type a name for the custom watermark (up to 24 characters long) in the **Watermark** field. Click the **Save** button to add it to the list, then click **OK**.

The custom watermark now appears as the selected watermark in the Watermark Settings dialog box and is shown in the on-screen graphic.



Note:

If your monitor displays only 16 colors, the Intensity adjustments are not shown in the on-screen graphic. If you choose the No Halftoning setting, the Intensity setting does not determine how your watermark is printed.

- 5 Select the way you want the watermark to appear by choosing the following options. The on-screen graphic changes to reflect all the settings you choose.
 - ▶ **Position** selects where you want the watermark to appear on your page: **Center**, **Top-Left**, **Top-Center**, **Top-Right**, **Left**, **Right**, **Bottom-Left**, **Bottom-Center**, or **Bottom-Right**.
 - ▶ **Size** adjusts the size of the watermark, either larger or smaller, as you move the slide bar.
 - ▶ **Color** lets you choose a color for your predefined watermark: **Red**, **Black**, **Blue**, **Aqua**, **Lime**, **Fuchsia**, or **Yellow**. You cannot select a color for a custom watermark; it is printed in its original colors.
 - ▶ **Intensity** sets the lightness or darkness of the watermark (from 5% to 100%) based on where you move the slide bar.
- 6 If you're finished changing Layout options, click **OK** to close the Layout dialog box.

Saving Custom Settings

After you've fine-tuned your printer settings for a special project, you can save the settings as a group. Then you can quickly reuse them the next time you print a similar project. You can save up to 10 groups of settings (one in Windows 3.1).

- 1 Customize your printer settings, as described in [Customizing Print Quality and Special Effects](#).
- 2 Make sure you're on the Advanced dialog box. (In Windows 3.1, access the main printer settings dialog box as described in [Setting Printer Options from Windows Applications](#).)

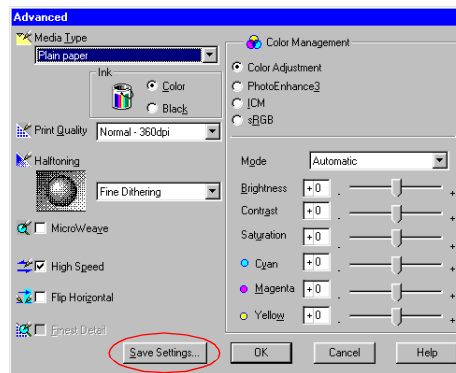

Windows 95, 98, NT



Note:

You can save only the settings on the Main tab and Advanced dialog box. You cannot save the settings on the Paper and Layout tabs.

You cannot save your custom settings with the predefined custom setting type names provided by EPSON.

- 3 Click the **Save Settings** button. You see this dialog box:

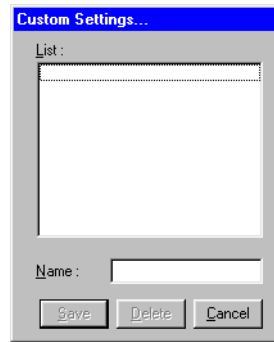

- 4 Type a unique name for your settings (up to 16 characters) and click the **Save** button.
- 5 Click **OK** to close the Advanced dialog box (not necessary with Windows 3.1).

The name you choose will now be available in the Custom Settings list on the main printer settings dialog box. To use the settings, click **Custom** (in Windows 3.1, click **Advanced**). Then open the Custom Settings list and click the name you selected for your custom settings group.

To redefine or delete your custom settings, see [Redefining Custom Settings](#) or [Deleting Custom Settings](#).

Redefining Custom Settings

To change the options in a customized settings group but keep the same name for it, follow these steps:

- 1 From the Main printer settings dialog box, click **Custom** (in Windows 3.1, click **Advanced**). Then select the name of the custom settings group you want to redefine in the Custom Settings list.
- 2 Click the **Advanced** button (in Windows 3.1, click **More Settings**) and change the printer settings as necessary. (If you change the **Media Type** and **Ink** settings, the custom settings group name reverts to Custom Settings; this doesn't affect your customized setting, but you'll need to reselect the name in step 6.)
- 3 Click **Save Settings**. (In Windows 3.1, click **Save Settings** on the main printer settings dialog box.)
- 4 Select the name of the custom settings group you're redefining in the Custom Settings dialog box.
- 5 Click **Save**. You see a message asking if you want to overwrite the previous settings. Click **OK** to save your redefined settings. (Click **Cancel** to cancel your changes.)

Deleting Custom Settings

- 1 From the Main dialog box, click **Custom**, then click the **Advanced** button. Click **Save Settings** on the Advanced dialog box. (In Windows 3.1, click **Advanced**, then click **Save Settings** on the main printer settings dialog box.)
- 2 Select the custom settings group in the Custom Settings box, and click **Delete**. Then click **OK** to confirm the deletion, if necessary. (You cannot delete any of the predefined document types.)

Printing on Special Media

Your EPSON Stylus COLOR 640 lets you print on just about any kind of paper you want to use. You can get great results printing on various sizes of plain paper, letterhead, and envelopes, but you'll get even better results with specially coated ink jet paper.

For the best output, use EPSON's photo-quality paper: ink jet paper, glossy paper, glossy film, note cards, and photo paper. For special projects, you can use a variety of EPSON media designed for ink jet printers, ranging from transparencies to iron-on transfer paper.

This chapter covers the following:

- ▶ [Selecting Special Media](#)
- ▶ [Media Loading and Handling Guidelines](#)

Selecting Special Media

When you print on special media, you need to choose the correct **Media Type** and **Paper Size** settings in your printer software. The table below lists the available EPSON media and the corresponding **Media Type** setting for each one.

Media name	Size	Part number	Media Type setting
EPSON 360 dpi Ink Jet Paper	Letter A4	S041060 S041059	360 dpi Ink Jet Paper
EPSON Iron-On Cool Peel Transfer Paper	Letter	S041153/S041155	
EPSON High Quality Ink Jet Paper	Letter A4	S041111 S041117	Photo Quality Ink Jet Paper
EPSON Photo Quality Ink Jet Paper	Letter A4 Legal	S041062 S041061 S041067	
EPSON Photo Quality Ink Jet Cards	A6 (4.1 × 5.8 inches) 8 × 10 inches	S041054 S041122	
EPSON Ink Jet Note Cards (with envelopes)	A6 (4.1 × 5.8 inches)	S041147	
EPSON Photo Quality Self Adhesive Sheets	A4	S041106	

Media name	Size	Part number	Media Type setting
EPSON Photo Quality Glossy Paper	Letter A4	S041124 S041126	Photo Paper
EPSON Photo Paper	4 × 6 inches Letter A4 Panoramic	S041134 S041141 S041104 S041145	
EPSON Photo Quality Glossy Film	Letter A4 A6 (4.1 × 5.8 inches)	S041072 S041071 S041107	Photo Quality Glossy Film
EPSON Photo Stickers Kit (CD-ROM and paper) EPSON Photo Stickers (refill, paper only)	A6 (4.1 × 5.8 inches) A6 (4.1 × 5.8 inches)	S041144-KIT S041144	
EPSON Ink Jet Transparencies	Letter A4	S041064 S041063	Ink Jet Transparencies

To order EPSON media, contact your dealer or call EPSON Accessories at (800) 873-7766 (U.S. only). In Canada, please call (800) 873-7766 for dealer referral.



Caution:
Don't use the cleaning sheets that may be included with your special media; they may damage the printer.

Media Loading and Handling Guidelines

The type of paper or other media you use is one of the most important factors in determining the quality of your printed output. The following tips will help you get the best results on any type of paper or other media:

- ▶ Be sure to load the printable (whiter) side of the media face up in the sheet feeder.
- ▶ You can load paper up to the arrow mark on the left edge guide.
- ▶ Always handle sheets by the edges, and don't touch the printable surface.
- ▶ In addition to the **Media Type** option, remember to select the correct **Paper Size** for your media on the Paper menu.
- ▶ If the special media has protective sheets between the sheets of media, be sure to remove the protective sheets before printing.

- ▶ Set the thickness lever to the + position when you print on envelopes or if ink smears when you print on other thick media. Open the printer cover and position the lever as shown below. Then close the cover and print. (Make sure you return the lever to the 0 position before you print on regular media.)

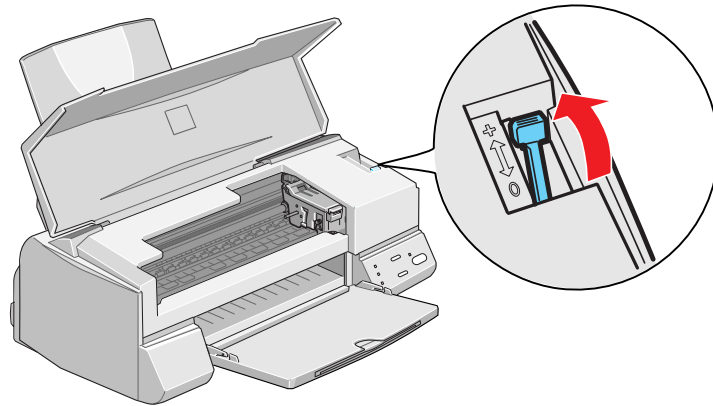

- ▶ Use ink jet papers within one year of purchase. Use glossy media and transparencies within six months. Return unused sheets and envelopes to their original packages as soon as possible. See [Paper](#) for more media storage information.

- ▶ Some media require additional loading instructions. See the following sections for more information about:
 - ▶ [Letterhead, Preprinted Forms, and Legal-size Paper](#)
 - ▶ [Envelopes](#)
 - ▶ [EPSON Photo Quality Ink Jet and Note Cards](#)
 - ▶ [EPSON Ink Jet Paper](#)
 - ▶ [EPSON Photo Quality Glossy Film](#)
 - ▶ [EPSON Photo Quality Glossy Paper](#)
 - ▶ [EPSON Photo Paper](#)
 - ▶ [EPSON Ink Jet Transparencies](#)
 - ▶ [EPSON Photo Stickers](#)
 - ▶ [EPSON Photo Quality Self Adhesive Sheets](#)
 - ▶ [EPSON Iron-On and Iron-On Cool Peel Transfer Paper](#)

Letterhead, Preprinted Forms, and Legal-size Paper

Load the top edge first. When you load legal-size paper, pull up the paper support extension and both output tray extensions. Load a maximum of 100 sheets.

Envelopes



Note:
If the stack of envelopes is more than 0.4-inch (10 mm) thick, press each envelope flat before stacking it or load one envelope at a time.

You can load up to 10 envelopes at a time. Load the envelope flap edge first and printable side up. Place it against the right edge guide and adjust the left edge guide as shown:

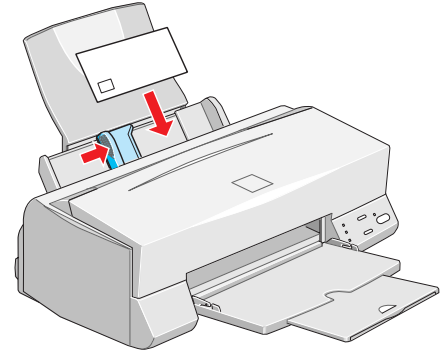

Select **Plain paper** as the Media Type and choose the correct envelope size as the Paper Size setting in the printer software.

Set the thickness lever to the **+** position when you print on envelopes. Open the printer cover and position the lever as shown below. Then close the cover and print. (Make sure you return the lever to the **0** position before you print on regular media.)

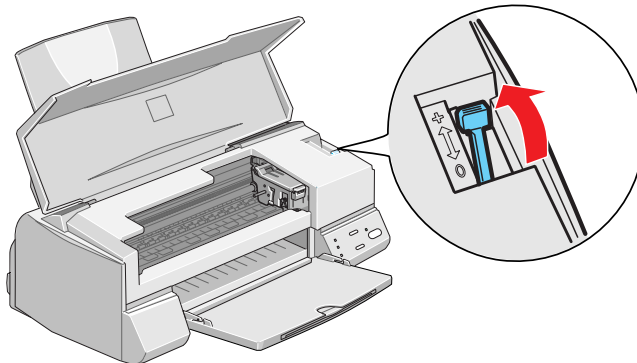

EPSON Photo Quality Ink Jet and Note Cards

Use these cards to print photos, postcards, or greeting cards.

You can load up to 30 cards at a time. Always place the included support sheet under the cards. Be sure the cards are against the right edge guide and the left edge guide is against the left edge of the cards.

When you're ready to print, use your software to set the **Paper Size** option for the size card you're using and set the Media Type to **Photo Quality Ink Jet Paper**. If ink smears on the cards, set the paper thickness lever to the **+** position as shown in [Envelopes](#).

EPSON Ink Jet Paper

Load up to 65 letter size or 25 legal size sheets.

For EPSON 360 dpi Ink Jet Paper, select **360 dpi Ink Jet Paper** as the Media Type.

For EPSON Photo Quality Ink Jet Paper, select **Photo Quality Ink Jet Paper** as the Media Type.

EPSON Photo Quality Glossy Film

Before you load glossy film, put a support sheet (packed with the media) or a plain paper sheet beneath the stack.

Load up to 20 sheets of Photo Quality Glossy Film and select **Photo Quality Glossy Film** as the Media Type.

You may get better results by loading one sheet at a time. With multiple sheets loaded, the minimum top margin you can use is 1.2 inches (30 mm). If you want to use a smaller top margin, load and print one sheet at a time.

If your media has a cut corner, position it in the printer as shown here.



Note:

It is best not to use the **Maximum** printable area setting in the printer software when printing on paper with a cut corner. Part of your document may print in the cut out area.

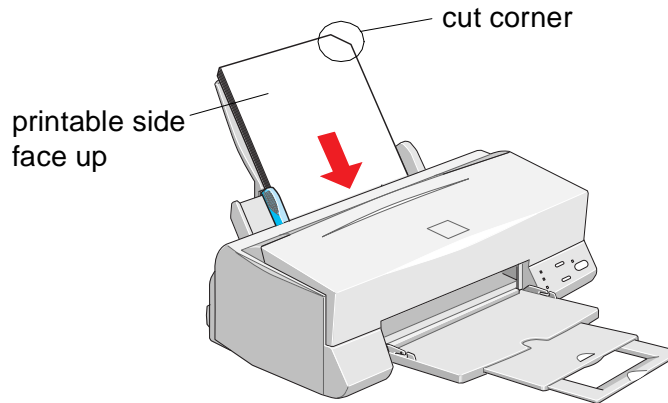

Remove each sheet from the output tray immediately after it's printed. Make sure each sheet is dry before stacking.

EPSON Photo Quality Glossy Paper

Load up to 20 sheets of Photo Quality Glossy Paper and select **Photo Paper** as the Media Type. Don't use a support sheet with this media.

Remove each sheet from the output tray immediately after it's printed. Make sure each sheet is dry before stacking.

EPSON Photo Paper

You can use EPSON Photo Paper to print photographs that look almost as good as the ones you get from film processing. EPSON Photo Paper is available in several sizes. 4 × 6-inch Photo Paper is perforated around the edges, so you can trim your printouts and “bleed” the photo—extend it to the edge of the paper—on all sides.

You can load up to 20 sheets of 4 × 6-inch, letter-size, or A4-size Photo Paper or 1 sheet of Panoramic paper at a time. Make sure you place a support sheet beneath the paper if it is included in the paper package.

To keep your printouts looking their best, store them in a resealable plastic bag or other airtight covering and protect them from heat, humidity, and direct sunlight. Return unused paper to the original package as soon as you finish printing.

Keep the following in mind when using EPSON Photo Paper:

- ▶ Load the paper with the whiter (glossier) side facing up.
- ▶ If you're loading Panoramic Photo Paper, pull up the paper support extension. Then load the Panoramic paper and hold up its top edge while you press the  load/eject button to feed it into the printer.

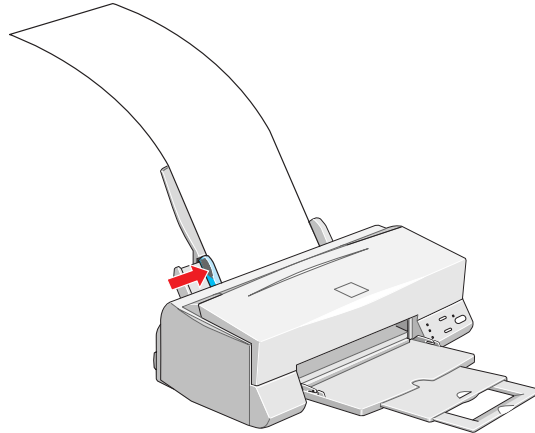

For the Paper size setting, choose **Panoramic 210 × 594 mm**.

Be sure to support your Panoramic Photo Paper as it ejects from the printer so it doesn't fall onto the floor.

- ▶ If you're using 4 × 6-inch Photo Paper, follow these steps:
 - 1 Load the paper against the right edge guide with the glossy side facing up and the perforated margins positioned as shown:

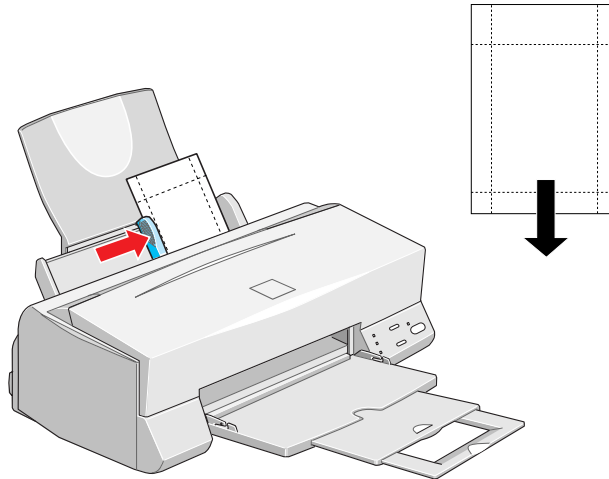

You can load up to 20 sheets of Photo Paper at a time. Make sure you place the included support sheets A and B beneath the stack, but don't print on them.

- 2 Slide the left edge guide against the left edge of the paper.

- 3 When you create the image in your application software, size it to 4.25×6.25 inches. You can also use your printer software's **Reduce/Enlarge** settings, as described in [Reducing and Enlarging Your Document Size](#).

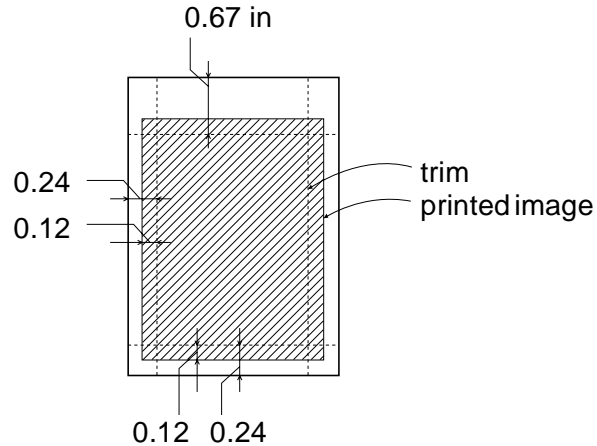

- 4 Choose **Photo Paper** as the Media Type setting.
- 5 Choose **Photo Paper 4 × 6 in** as the **Paper Size** setting and **Maximum** as the **Printable Area** setting.
- 6 After you print your picture, fold the paper back and forth along the perforations and carefully tear the margins off.

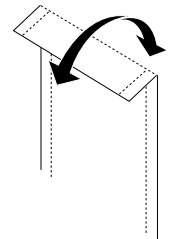

EPSON Ink Jet Transparencies

Before you load transparencies, place the included support sheet or a plain paper sheet beneath the stack. You can load up to 30 transparencies. However, you may get better results by loading one sheet at a time. Select **Ink Jet Transparencies** as the Media Type in the printer software.

EPSON Photo Stickers

Use these sheets of stickers to print small, decorated photos for use on cards, invitations, or other items. You'll need to use an application that creates photo stickers, such as StickerPIX.™

Load one sheet of Photo Stickers at a time. Make sure to place support sheets A and B that came with the stickers beneath the sheet.

Select **Photo Quality Glossy Film** as the Media Type and **A6 Index 105 × 148 mm** as the Paper Size setting in the printer software.

EPSON Photo Quality Self Adhesive Sheets

Use these sheets to print labels or stickers. You can load one sheet at a time. Make sure your adhesive sheets are fully adhered to their backing sheet before you load them. Set the Media Type to **Photo Quality Ink Jet Paper** in the printer software.

EPSON Iron-On and Iron-On Cool Peel Transfer Paper

You can print photos, company logos, or anything else you want on these transfer papers, and then iron your images onto T-shirts or other cotton cloth items.

Load one sheet of transfer paper at a time. For Iron-On Transfer Paper, select **Ink Jet Transparencies** as the Media Type setting. For Iron-On Cool Peel Transfer paper, select **360 dpi Ink Jet Paper** as the Media Type setting.

Make sure you reverse your image before you print it—especially if it includes text—so it will read correctly when it's transferred. You can use the **Flip Horizontal** option in your printer software to do this (see [Customizing Print Quality and Special Effects](#) for instructions).

After you print, follow the instructions that came with the paper to iron the image onto the shirt or other item.

Managing Print Jobs

You can use your printer software to manage print jobs, monitor your printer's status, and handle network printing.

This chapter provides instructions for the following:

- ▶ [Managing Print Jobs in Windows 95, Windows 98, and Windows NT 4.0](#)
- ▶ [Managing Print Jobs in Windows 3.1](#)
- ▶ [Network Printing in Windows 95 and Windows 98](#)



Note:

Windows NT 4.0 includes a messenger service to alert you to printer errors or let you know when a print job is finished. If you have appropriate network access privileges or you're controlling printing from the server, you can also set other options. See your Windows NT documentation for details.

Managing Print Jobs in Windows 95, Windows 98, and Windows NT 4.0

Your printer software offers three ways to manage and monitor your print jobs:

- ▶ Progress Meter, which appears each time you send a print job, as described in [Checking Print Job Status](#). You can turn the Progress Meter on or off and select other printing options using the **Speed & Progress** button; see [Selecting the Speed & Progress Options](#) for details.
- ▶ Spool Manager (not available with Windows NT), which appears in the taskbar at the bottom of the screen each time you print, as described in [Using the Spool Manager](#).
- ▶ Status Monitor 2, which provides a variety of print monitoring options, as described in [Using Status Monitor 2](#).

Selecting the Speed & Progress Options

You can set up the way your printer software sends print jobs and select whether to display the Progress Meter using the Speed & Progress dialog box. To access the dialog box, you must open your printer software from the Printers utility as described below.

- 1 Click **Start**, point to **Settings**, then click **Printers**.
- 2 Right-click the **EPSON Stylus COLOR 640** printer icon and select **Properties** (Windows 95 and 98) or **Document Defaults** (Windows NT) from the menu.
- 3 Click the **Utility** tab. You see the Utility menu:

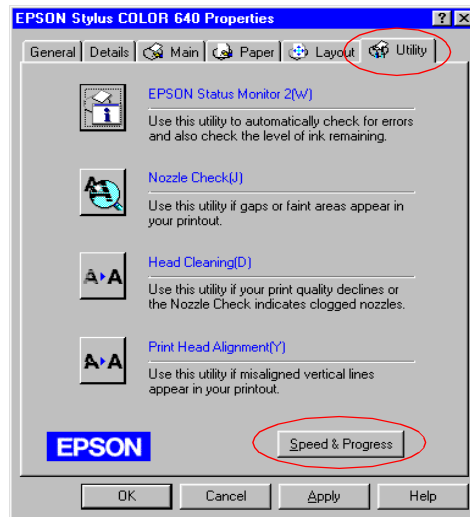



Note:

The folder you select in the High Speed Copy Folder section is also the default spool directory. Try changing this folder if you get an error message when trying to print.

4 Click the **Speed & Progress** button. You see this dialog box:

not available with
Windows NT

appears only if
you have more
than one hard
disk drive

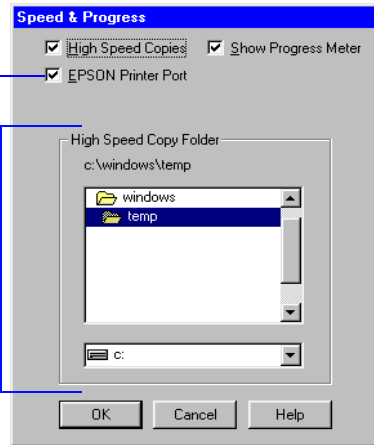

Select from the following options:

- ▶ **High Speed Copies** speeds up printing of multiple copies of the same document by using hard disk space as a cache.
- ▶ **Show Progress Meter** lets you control whether or not the Progress Meter is displayed when you send a print job. See [Checking Print Job Status](#).
- ▶ **EPSON Printer Port** (not available with Windows NT 4.0) lets you optimize the transfer rate of your printer port for EPSON printers instead of using the Windows default printer port. You may see one of these messages beneath the **EPSON Printer Port** option:
 - ▶ **High speed (DMA) transfer enabled** tells you that you're already using fast DMA transfer mode.
 - ▶ **For higher data transfer rates, use DMA transfer** lets you know that you can speed up printing by enabling DMA transfers on your system. See your computer documentation for details.

If you see no message, you cannot enable DMA transfers on your system.

- 5 Click **OK** to close the Speed & Progress dialog box and return to the Utility menu. Then click **OK** again to close the printer software window.

Using the Spool Manager

The Spool Manager (not available with Windows NT) creates a temporary print job file and stores it in the C:\TEMP or C:\WINDOWS\TEMP folder or directory. The software then sends the file to your printer at the right time.

To open Spool Manager while you're printing, click the **EPSON Stylus COLOR 640** button that appears on the taskbar at the bottom of the screen.

You see the Spool Manager window:

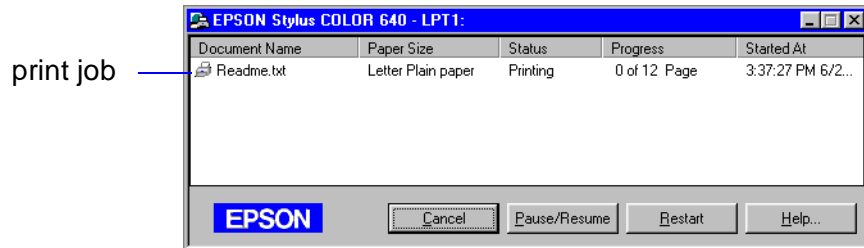

The Spool Manager window displays the status of your print job files and lets you control them. To cancel, pause, resume, or restart a print job, click the job to highlight it; then click one of the command buttons on the bottom of the window.

Deleting a Stalled Print Job

If you're having trouble printing, it may be because of a stalled print job. Follow these steps to delete it and continue printing:

- 1 Click the **EPSON Stylus COLOR 640** button on the taskbar.
- 2 Click on any print jobs marked **Held**.
- 3 Click the **Cancel** button.
- 4 Exit the Spool Manager and try printing again.

Using Status Monitor 2

Status Monitor 2 lets you view detailed information about your print jobs and control how you want printing monitored. Before using Status Monitor 2, you must enable background monitoring for your printer, if it isn't already enabled.

The instructions in the following sections describe:

- ▶ [Enabling Background Monitoring](#)
- ▶ [Setting Up Monitoring Preferences](#)
- ▶ [Using the Status Monitor 2 Main Window](#)
- ▶ [Using the Printer Status Window](#)
- ▶ [Using the Job Status Window](#)



Note:

You can use Status Monitor 2 only if it is installed and your printer is connected directly to the computer. Also, your computer must be configured to support bidirectional communication.



Note:

ScanDisk will not run if Status Monitor 2 is performing background monitoring. To disable background monitoring, right-click the  icon on the taskbar in the bottom right corner of your screen and select **Stop monitoring now**.

Enabling Background Monitoring

You can enable background monitoring for your printer if you want Status Monitor 2 to alert you to error conditions while you're working on other tasks.

- 1 Click **Start**, point to **Programs**, point to the **Epson** folder, and click **EPSON Status Monitor 2** to open Status Monitor 2.
- 2 Click **EPSON Stylus COLOR 640** in the Printer Name list. The printer name is highlighted.
- 3 Open the Settings menu and select **Background Monitoring**.
- 4 Select either **Monitor from restart** (to begin background monitoring after your next system restart) or **Monitor now** (to begin background monitoring right away).

Now set your monitoring preferences for the printer as described in [Setting Up Monitoring Preferences](#).



Note:
Background monitoring must be on to change Background Monitoring and Status Alert preferences in the Monitoring Preferences window. See [Enabling Background Monitoring](#).

Setting Up Monitoring Preferences

You can select the way you want Status Monitor 2 to monitor your printer in the Monitoring Preferences window. There are several ways to open the window:

- ▶ Click the printer name in the Installed Printers list to highlight it and click the  icon or select **Monitoring Preferences** from the Settings menu.
- ▶ Right-click the printer name in the Installed Printers list and select **Monitoring Preferences**.

You see the Monitoring Preferences window:

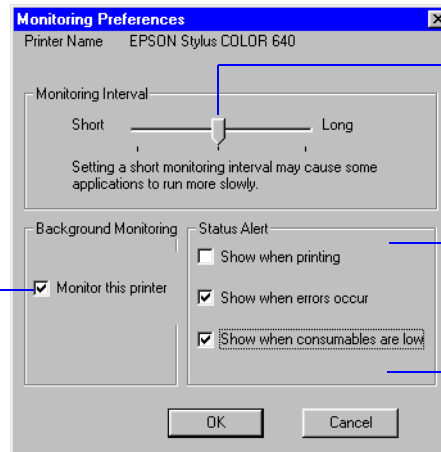

Turn background monitoring on or off for the selected printer

Set the length of the interval in which you want Status Monitor 2 to monitor your printer here (short intervals may cause some applications to run slower)

Select if and when to use the Status Alert dialog box: while printing, when errors occur, and/or when ink is low

If you turn on one or more of the Status Alert options, you'll see the Status Alert dialog box when the selected condition occurs. For example, if you turn on **Show when errors occur**, the dialog box appears only if a printing error occurs. If you select all the options, the dialog box appears whenever you print, encounter an error, or have low ink levels.

The color of the installed printer icon in the Status Alert dialog box indicates the type of error, as described in [Interpreting the Installed Printer Icon](#).

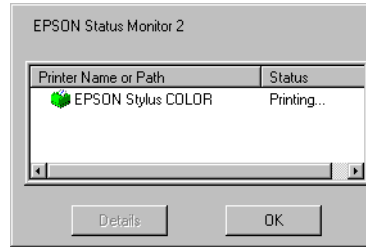

Using the Status Monitor 2 Main Window

Once you've enabled background monitoring for your printer and set preferences, there are several ways to access Status Monitor 2:

- ▶ Double-click the  icon on the taskbar in the bottom right corner of your screen.
- ▶ Click **Start**, point to **Programs**, click the **Epson** folder, and click **EPSON Status Monitor 2**.

When you start Status Monitor 2, you see the main window:

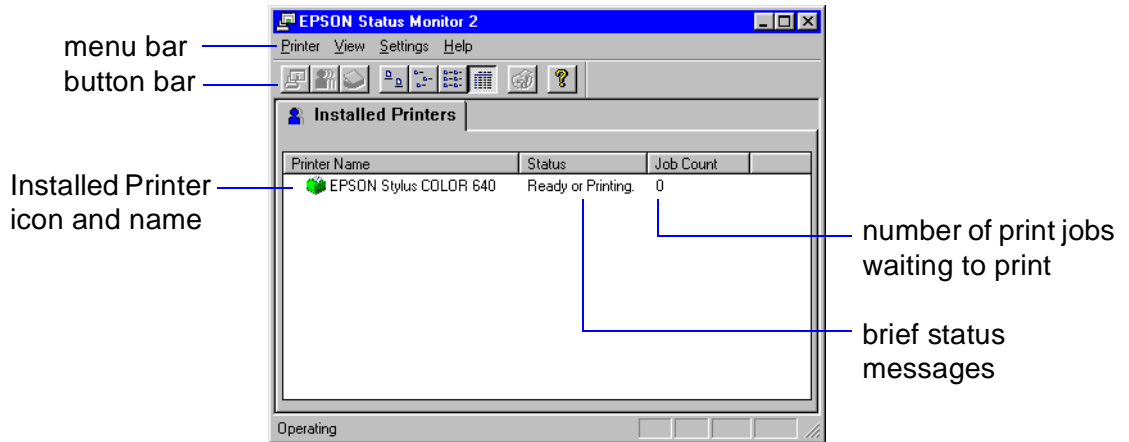

If you have more than one printer you want to monitor, you can add them using the **Add Printer** option in the Settings menu. You can reorder the monitored printers, in the Installed Printers list by clicking in the Printer Name, Status, or Job Count title bar.

To save system resources, you may want to delete any printers from the Status Monitor 2 list that you don't need to monitor. To do this, click the printer in the Installed Printers list and select **Delete Printer** from the Settings menu.

The color of the Installed Printer icon indicates the printer status, as described in the following table:

Interpreting the Installed Printer Icon

Installed Printer icon color	Status message
Green	Ready to print.
Yellow	Paper and/or ink level is low.
Red	Paper and/or ink is out, paper is jammed, or a print or communication error has occurred.
Gray	Printer not detected.



You can change the shape of the Status Monitor 2 printer icon by clicking the Select background monitoring icon in the Settings menu and selecting the icon you want to use.

You can customize the appearance of items on the Status Monitor 2 main window using the View menu options or icons on the button bar.

Using the Printer Status Window

For more details on the status of your printer, you can use the Printer Status window. There are several ways to open the window:

- ▶ Double-click the printer name in the Installed Printers list.
- ▶ Click the printer name in the Installed Printers list to highlight it and click the  icon or select **Printer Status** from the Printer menu.

- ▶ Right-click the printer name in the Installed Printers list and select **Printer Status**.
- ▶ If you're currently using the printer software, click the **Utility** tab, then click the **EPSON Status Monitor 2** icon.
- ▶ You can also access the Printer Status window by clicking the **Detail** button on the Progress Meter while you're printing (see [Checking Print Job Status](#)) or the Status Alert dialog box (see [Setting Up Monitoring Preferences](#)).

You see the Printer Status window. The Current Status tab gives printing status and error correction information.

Illustrations of what to do if an error occurs appear here.

If your printer runs out of ink, click this button to display cartridge replacement steps on the right and illustrations in the printer graphic area.

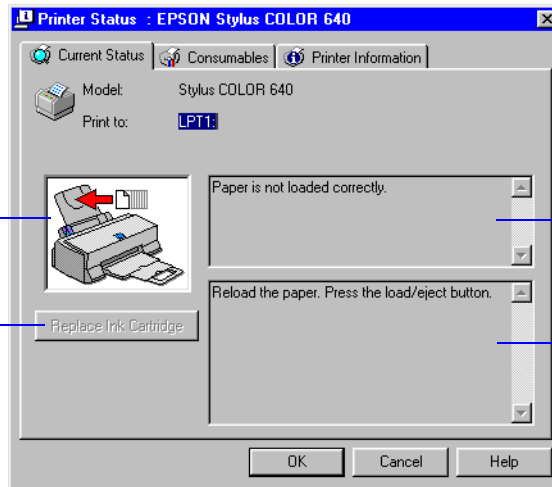



Printer status messages appear here.

If an error occurs, troubleshooting tips appear here.

The printer graphic in the Printer Status window gives status and error condition information, as described in the following table:

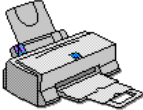
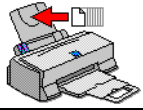
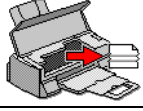
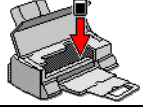
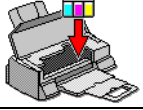
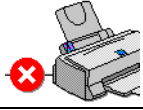
Status and Error Conditions

Graphic	Condition
	Ready to print
	Paper isn't loaded correctly
	Paper is jammed
	Black ink is out
	Color ink is out
	A communication error has occurred
	Another type of printer error has occurred

To check the amount of ink you have, click the **Consumables** tab.

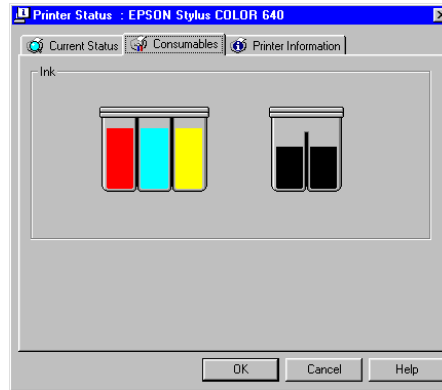

The **Printer Information** tab does not display information for your printer.



Note:

The Job Status window is very similar to the Spool Manager window. Both allow you to pause, cancel, and restart print jobs. See [Using the Spool Manager](#) for more information.

Using the Job Status Window

To view detailed information on the print jobs waiting to print on your printer, open the Job Status window (not available with Windows NT). There are several ways to open the window:

- ▶ Click the printer name in the Installed Printers list to highlight it and click the  icon or select **Job Status** from the Printer menu.
- ▶ Right-click the printer name in the Installed Printers list and select **Job Status** from the menu.

You see the Job Status window:

print job information appears here

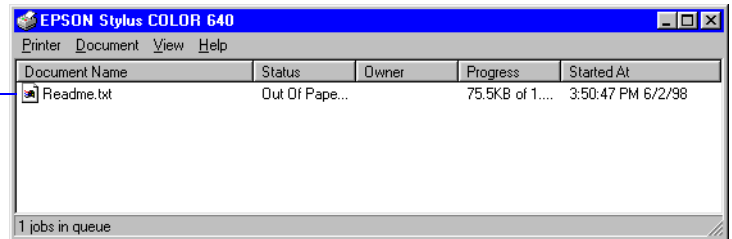

Options in the Printer menu let you pause printing or purge all waiting print jobs for the printer, select or deselect the printer as your Windows default, and access the printer software to change default settings.

The Document menu options let you pause or cancel printing of individual printing jobs. Click the print job you want to pause or cancel in the Document Name list to highlight it.

Managing Print Jobs in Windows 3.1

Your Windows printer software includes two management utilities: the Spool Manager and Despooler.

- ▶ The Spool Manager starts automatically when you send a job to the printer. It allows you to print in the background while you continue to work on your computer and to hold jobs to print at a later time. If you're using your printer on a network, it also handles multiple print jobs that come in at the same time. See [Using the Spool Manager](#) for details.
- ▶ The Despooler also starts automatically when you send a job to the printer. It displays on your screen to show printer status, as described in [Checking Print Job Status](#).

Using the Spool Manager

The Spool Manager works like the Windows Print Manager. When you send a job to your printer, your printer software creates a temporary print job file, stores it in the C:\TEMP or C:\WINDOWS\TEMP directory, and assigns it to a print queue. The software then sends the file to your printer at the right time.



Note:

You may not see the Spool Manager icon if the Program Manager or current window is maximized. Reduce the window size to see the Spool Manager icon.

- ▶ To open the Spool Manager while you're printing, click the **Spool Manager** icon that appears at the bottom of your desktop.
- ▶ You can open the Spool Manager at any time by double-clicking the **Spool Manager4** icon in the EPSON program group.

You see the Spool Manager window:

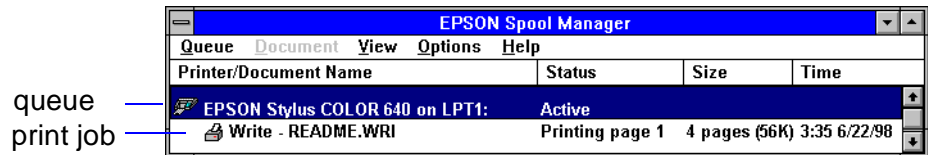

The Spool Manager window displays the status of your print queues and print jobs and lets you control them. You can also control the display of the Despooler and the default spool directory. Click **Help** in the Spool Manager menu bar for detailed information.

Deleting a Stalled Print Job

If you're having trouble printing, it may be because of a stalled print job. Follow these steps to delete it and continue printing:

- 1 Open the Spool Manager as described in [Using the Spool Manager](#).
- 2 Click on any print jobs marked **Held**, then open the Document menu and click **Delete**. Then click **Yes**.
- 3 Exit Spool Manager and try printing again.

Changing the Default Spool Directory

If you get an error message when you try to print, or printing is very slow, you can try changing your default spool directory.

- 1 Make a directory on your hard disk where you want Spool Manager to store print job files, for example, C:\SPLTEMP.
- 2 Open the Spool Manager as described in [Using the Spool Manager](#).
- 3 Choose **Default Spool Directory** from the Options menu.
- 4 In the dialog box, change the spool directory to the one you created in step 1. Then click **OK**.

- 5 Make sure **EPSON Stylus COLOR 640** is selected, and then choose **Setup** from the Queue menu. The Queue Setup dialog box appears.
- 6 Make sure the spool directory is the one you created in step 1. Also make sure **Use Print Manager for this port** is checked. Then click **OK**.
- 7 Close Spool Manager.



Note:

If you're using your printer on a Windows NT 4.0 network, see your network administrator or your Windows NT documentation for instructions on configuring your printer for the network.

Network Printing in Windows 95 and Windows 98

If your computer is on a Windows 95 or Windows 98 network and you want other users to share the printer connected to it, you need to:

- 1 Set up the system connected to the printer (host system) so the printer can be shared (see [Setting Up the Host System for Printer Sharing](#)).
- 2 Define a path to the printer on each client computer (see [Setting Up Client Systems to Share the Printer](#)).

Before following the steps here, make sure you've installed the printer software on all the computers that will use the printer. See the *Start Here* card for instructions.

Setting Up the Host System for Printer Sharing

- 1 Click **Start**, point to **Settings**, and select **Control Panel**.
- 2 Double-click **Network**, then click the **File and Print Sharing** button.
- 3 Click the **I want to be able to allow others to print to my printer(s)** checkbox and click **OK**.
- 4 In the Network window, click **OK**.
- 5 In the Control Panel, double-click **Printers**. Right-click the **EPSON Stylus COLOR 640** icon, then click **Sharing**.
- 6 Click the **Share As** button. Then enter a Share Name, Comment, and Password as necessary and click **OK**.
- 7 Restart your system so the settings take effect.

Setting Up Client Systems to Share the Printer

- 1 Click **Start**, point to **Settings**, and select **Printers**.
- 2 Right-click the **EPSON Stylus COLOR 640** icon and choose **Properties**.
- 3 Click the **Details** tab. You see the following dialog box:

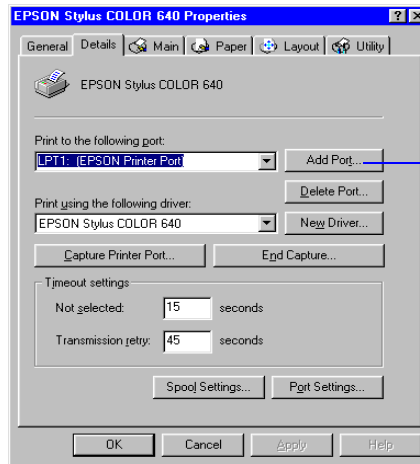

Click **Add Port**, then specify the network path in the dialog box that appears

- 4 Click the **Add Port** button, then click **Browse** to specify the network path to the printer.
- 5 Click **OK** to return to the Details dialog box, then click **OK** to save your settings and exit.

Maintenance and Transportation

It's easy to keep your EPSON Stylus COLOR 640 printer working at its best. All you have to do is follow the simple instructions in this chapter for replacing ink cartridges, moving the printer, and performing routine maintenance.

This chapter covers the following procedures:

- ▶ [Cleaning the Print Head](#)
- ▶ [Replacing an Ink Cartridge](#)
- ▶ [Aligning the Print Head](#)
- ▶ [Cleaning the Printer](#)
- ▶ [Transporting the Printer](#)



Caution:
Don't use the cleaning sheets that may be included with your special media; they may damage the printer.

Cleaning the Print Head

If your printed image is unexpectedly light or faint, or dots are missing from the image, you may need to clean the print head. This unclogs the print head nozzles so they can deliver ink properly.



Cleaning the print head uses ink, so clean it only if print quality declines. You can use either of the following to clean the print head:

- ▶ The Head Cleaning utility in your printer software (if the printer is on a local port, not on a network) (see [Using the Head Cleaning Utility](#))
- ▶ The printer's control panel buttons (see [Using the Printer Control Panel](#))

Do not clean the print head while printing is in progress; otherwise your printout may be marred.

Using the Head Cleaning Utility

Follow these steps to run the utility:

- 1 Make sure the printer is turned on but not printing, and that the  black and  color ink out lights are off. If either ink out light is on, you must replace the ink cartridge before cleaning the print head.
- 2 *Windows 95, Windows 98, and Windows NT 4.0:*

Click **Start**, point to **Settings**, and then select **Printers**.

Right-click the **EPSON Stylus COLOR 640** icon in the **Printers** window.

Select **Properties (Document Defaults** in Windows NT). Then click the **Utility** tab.

Windows 3.1:

Double-click the **Control Panel** icon in the Main group.

Double-click the **Printers** icon.

Select **EPSON Stylus COLOR 640** from the list of installed printers and click **Setup**.



Note:
You can also access the printer settings dialog box as described in [Setting Printer Options from Windows Applications](#).

- 3 Click the **Utility** tab. You see the Utility menu.

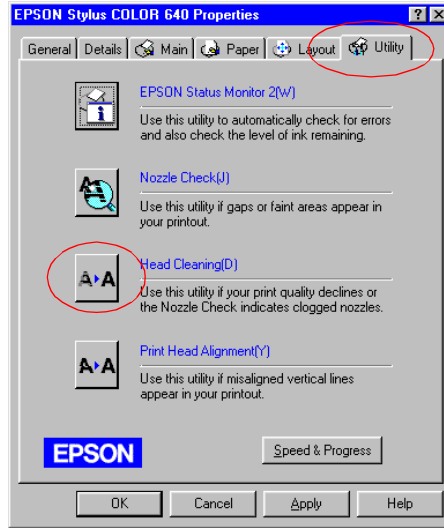

Caution:
Never turn off the printer while the power light is flashing, unless the printer hasn't moved or made any noise for more than 5 minutes.

- 4 Click the **Head Cleaning** button.
- 5 Follow the instructions on the screen to clean the print head. Cleaning takes about one minute, during which the printer makes some noise and the power light flashes.

When the cleaning cycle is finished (the power light stops flashing), you need to run a nozzle check to confirm that the print head nozzles are clean and to reset the printer's cleaning cycle.

- 6 Make sure paper is loaded in the printer and click **Print nozzle check pattern**. Then click **Next**. See [Examining the Nozzle Check Pattern](#) for instructions on examining the nozzle check pattern.
- 7 If the pattern looks okay, click **Finish** to close the Nozzle Check dialog box. If the pattern is missing dots, click **Clean** to clean the print head again.

If you don't notice any improvement after doing this three or four times, see [Improving Print Quality](#).

Using the Printer Control Panel

Follow these steps to clean the print head:



Caution:
Never turn off the printer while the power light is flashing, unless the printer hasn't moved or made any noise for more than 5 minutes.

- 1 Make sure the printer is turned on and not printing, and that the black and color ink out lights are off. If either ink out light is on, you must replace the ink cartridge before cleaning the print head.
- 2 Press the cleaning button and hold it down for three seconds. Cleaning takes about one minute, during which the printer makes some noise and the power light flashes.

After the cleaning cycle is complete and the power light stops flashing, you need to confirm that the print head nozzles are clean and reset the printer's cleaning cycle. You can do this by printing a page and or running a nozzle check (see [Using the Head Cleaning Utility](#)).

- 3 If your print quality has not improved, run another cleaning cycle. If you don't notice any improvement after doing this three or four times, see [Improving Print Quality](#).

Examining the Nozzle Check Pattern

Examine the nozzle check pattern after printing it. It should look something like this:

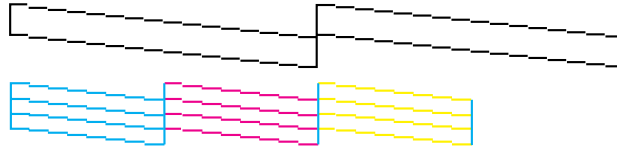

Each staggered horizontal and straight vertical line should be complete, with no gaps in the dot pattern. If your printout looks okay, you're done. If any dots are missing, as shown below, clean the print head again, as explained in the previous sections.

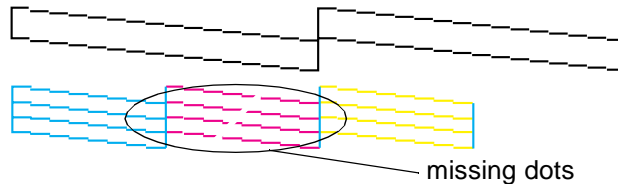



Caution:



To ensure good results, use genuine EPSON cartridges and do not refill them. Other products may cause damage to your printer not covered by EPSON's warranty.



Note:

If you need to replace an ink cartridge before the lights flash (because the ink is too old, for example) follow the instructions in [Replacing an Outdated Ink Cartridge](#).

Replacing an Ink Cartridge

When a  black or  color ink out light flashes, the indicated cartridge is low on ink. This is a good time to make sure you have a new cartridge. When the light stays on, the cartridge is empty and you need to replace it. You cannot print if either ink cartridge is empty.

Use these EPSON ink cartridges within six months of installing them and before the expiration date on the package:

- ▶ Black ink cartridge: S020187
- ▶ Color ink cartridge: S020191

When you need new ink cartridges, contact your dealer or call EPSON Accessories at (800) 873-7766 (U.S. sales only). In Canada, please call (800) 873-7766 for dealer referral.



Note:

If you press the  cleaning button when neither ink out light is flashing or on, the printer cleans the print head (see [Using the Head Cleaning Utility](#)).







Caution:

Never move the print head by hand.

Don't open the clamp or remove a cartridge except to replace it with a new one. Once you remove a cartridge, you can't reuse it.

Removing an Empty Ink Cartridge

You can replace a cartridge when the  black or  color ink out light is either flashing or on. Follow these steps:

- 1 Make sure the printer is turned on and not printing.
- 2 Lower the output tray and raise the printer cover.
- 3 Press the  cleaning button and hold it for three seconds. The print head moves slightly to the left and the  power light begins flashing.
- 4 Pull up the ink cartridge clamp. The cartridge rises up from its holder.

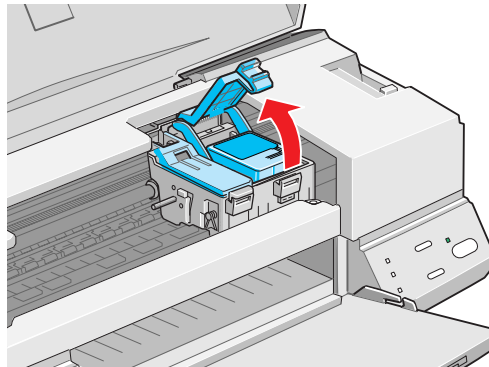



Warning:

If ink gets on your hands, wash them thoroughly with soap and water. If ink gets into your eyes, flush them immediately with water.



Caution:

You must remove only the yellow tape seal from the top of the cartridge; leaving the tape on will permanently damage it. Do not remove the clear seal from the bottom of the cartridge; ink will leak.

- 5 Lift the cartridge out of the printer and dispose of it carefully.
- 6 Follow the steps in the next section to install the new ink cartridge.

Installing the New Cartridge

Once you have removed the empty cartridge, you're ready to install the new one. Follow these steps:

- 1 Remove the new ink cartridge from its package.
- 2 Remove only the yellow part of the tape seal on the top of the cartridge. Do not remove the blue label. (It's okay if a bit of the yellow tape does not tear off.)

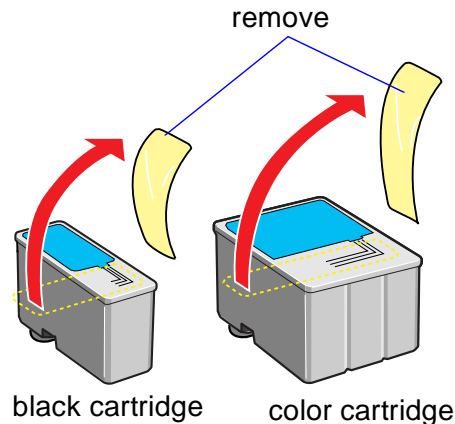

- 3 Lower the ink cartridge into its holder with the blue label facing up and toward the back of the printer.

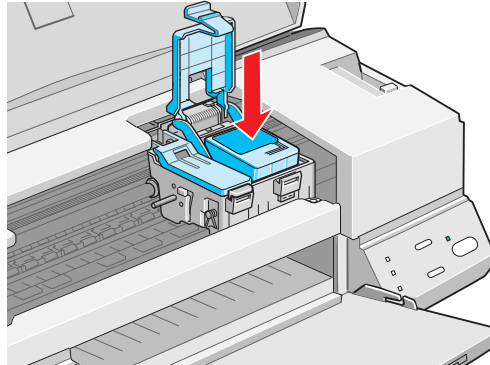

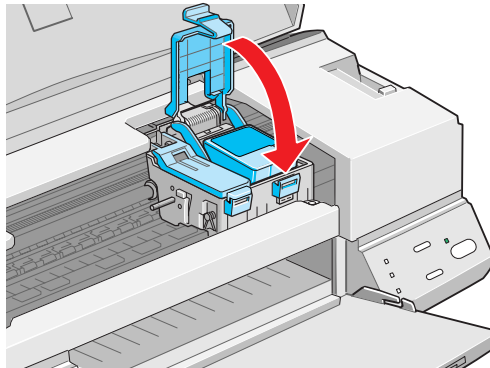

- 4 Press down the ink cartridge clamp until it locks in place.







Caution:
Never turn off the printer while the power light is flashing, unless the printer hasn't moved or made any noise for more than 5 minutes.

- 5 If you need to replace the other ink cartridge, remove it as described in [Removing an Empty Ink Cartridge](#). Then follow steps 1 through 4 in this section.
- 6 Press the  cleaning button and close the printer cover.
The printer moves the print head and begins charging the ink delivery system.
The  power light flashes and the printer makes various sounds. Charging takes about one minute. When it's finished, you can print again.

Replacing an Outdated Ink Cartridge

If an ink cartridge is more than six months old, you may need to replace it. How can you tell? You may notice that your printouts don't look as good as they used to. If print quality doesn't improve after cleaning and aligning the print head, try replacing one or both cartridges.

Follow these steps to replace an ink cartridge before the  black or  color ink out light is flashing or on:

- 1 Make sure the printer is turned on and not printing.
- 2 Lower the output tray and raise the printer cover.
- 3 Press the  load/eject button and hold it down for a few seconds until the print head moves to the left.



Caution:
To avoid damaging the printer, never move the print head by hand.



Warning:

If ink gets on your hands, wash them thoroughly with soap and water. If ink gets into your eyes, flush them immediately with water.



Caution:

Never turn off the printer while the power light is flashing, unless the printer hasn't moved or made any noise for more than 5 minutes.

- 4 Pull up the ink cartridge clamp. The cartridge rises up from its holder.
- 5 Lift the cartridge out of the printer and dispose of it carefully.
- 6 Remove the new ink cartridge from its packaging.
- 7 Remove only the yellow part of the tape seal on the top of the cartridge. Do not remove the blue label.
- 8 Lower the ink cartridge into its holder with the blue label facing up and toward the back of the printer.
- 9 Press down the ink cartridge clamp until it locks in place.
- 10 Press the  load/eject button and close the printer cover.

The printer moves the print head and begins charging the ink delivery system.

The power light flashes and the printer makes various sounds. Charging takes about one minute. When it's finished, you can print again.



For best results, use EPSON ink jet paper whenever you check the print head alignment.

Aligning the Print Head

If your printouts contain vertical banding or jagged vertical lines, you may need to align the print head. To use the print head alignment utility, your printer must be connected to a local port, not through a network. Follow these steps:

- 1 Make sure the printer is turned on and paper is loaded.
- 2 Access the printer settings dialog box as described in [Basic Printing](#).
- 3 Click the **Utility** tab. You see the Utility menu.
- 4 Click the **Print Head Alignment** button.
- 5 Follow the instructions on the screen to print a test page and select the correct alignment.



Caution:
Don't touch the gears
inside the printer.

Never use alcohol or
thinner for cleaning;
they can damage the
printer components
and case.

Don't get water on the
printer components.

Don't spray lubricants
or oils inside the
printer.

Cleaning the Printer

To keep your printer working at its best, you should clean it several times a year, following these steps:

- 1 Turn off the printer, unplug the power cord, and disconnect the printer cable.
- 2 Remove all the paper from the sheet feeder.
- 3 Clean the exterior of the printer with a soft, damp cloth.
- 4 Clean ink out of the printer's interior with a damp cloth.



Caution:

To avoid damage, always leave the ink cartridges installed when transporting the printer.

Transporting the Printer

If you want to move your printer some distance, you need to prepare it for transportation and repack it in the original box. Follow these steps:

- 1 Turn on the printer and wait until the print head locks in the far right position. Then turn off the printer.
- 2 Unplug the power cord from the electrical outlet. Then disconnect the interface cable from the printer.
- 3 Remove any paper from the sheet feeder and remove the paper support.
- 4 Push in the output tray extensions and close the tray.
- 5 Repack the printer and attachments in the original box using the protective materials that came with it. See the *Unpacking Sheet* that was packed with the printer.

Be sure to keep the printer flat as you transport it. If you notice a decline in print quality after transporting the printer, clean the print head (see [Cleaning the Print Head](#)); if output is misaligned, align the print head (see [Aligning the Print Head](#)).

Troubleshooting

As you use your printer, you may occasionally experience a paper jam or other problem. The first thing you should do is diagnose the problem, following the guidelines in this chapter. Then try the most likely solutions until the problem is fixed.

This chapter includes the following:

- ▶ [Identifying Printer Parts](#)
- ▶ [Diagnosing Problems](#)
- ▶ [Improving Print Quality](#)
- ▶ [Solving Printing Problems](#)
- ▶ [Solving Printer Software Problems](#)
- ▶ [Fixing Paper Problems](#)
- ▶ [Solving Miscellaneous Printout Problems](#)
- ▶ [Uninstalling Printer Software](#)
- ▶ [Where To Get Help](#)

Identifying Printer Parts

If you need help identifying the parts of the printer, refer to the following illustrations:

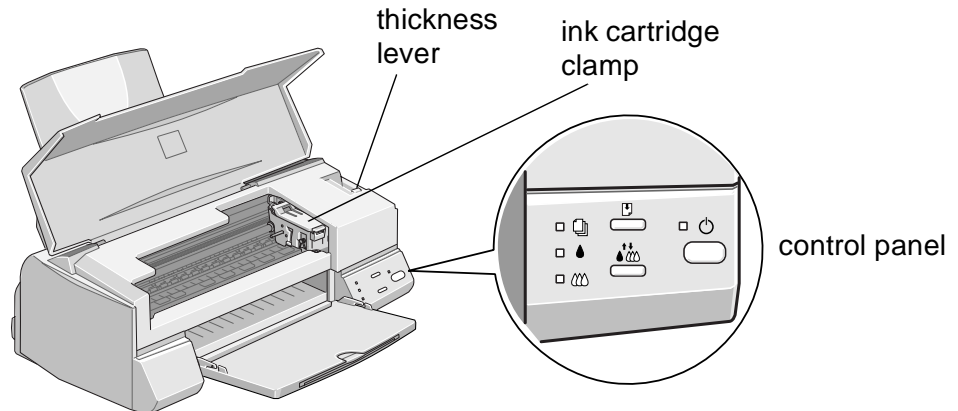
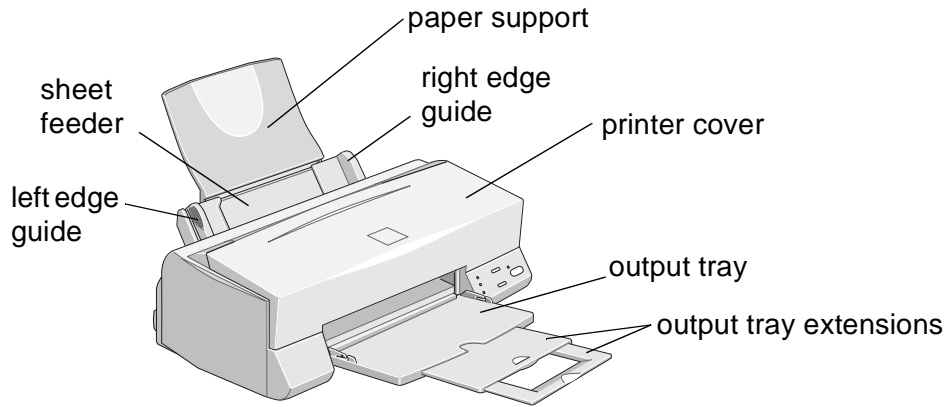

Diagnosing Problems

There are a number of ways to diagnose printer problems:

- ▶ To identify the most common problems, check the lights on the printer's control panel. See [Checking the Control Panel Lights](#).
- ▶ To determine whether the problem is caused by the printer itself, run a printer operation check. See [Running a Printer Check](#) for instructions.
- ▶ For the latest information, check the Help and ReadMe files in the EPSON program group or folder.
- ▶ See the troubleshooting tips in the “Problems? Need Help?” section of your *Printer Basics* book.
- ▶ If any of the suggested solutions in this chapter tell you to uninstall and then reinstall your printer software, see [Uninstalling Printer Software](#) for instructions.
- ▶ If none of the suggested solutions in this chapter solve your problem, contact your EPSON dealer or see [Where To Get Help](#).

Checking the Control Panel Lights

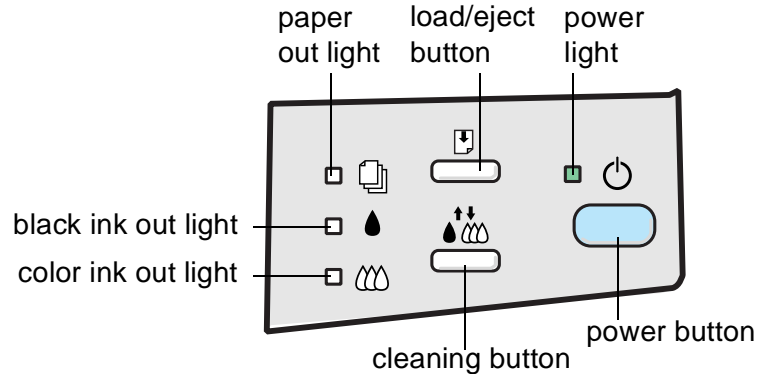

The four lights on your printer's control panel show the printer's status and alert you to problems like paper jams.

⏻ The power light is *on* when the printer is on and ready to print. The power light *flashes* when the printer is receiving a print job or performing a maintenance operation such as cleaning the print head.

💧 or 🍷 When an ink out light *flashes*, your ink supply is low. Make sure you have a replacement cartridge.





When an ink out light *comes on*, you need to replace the ink cartridge. See [Replacing an Ink Cartridge](#) for instructions.



When the paper out light *comes on*, your paper ran out or is incorrectly loaded. Make sure none of the sheets are curled, creased, old, stuck together, or too thin. Reload the paper against the right edge guide and slide the left edge guide over to the paper's left edge. Then press the  load/eject button.

When the paper out light *flashes*, you have a paper jam. Turn off the printer and gently pull out all paper. Make sure none of the sheets are curled, creased, old, stuck together, or too thin. Reload the paper against the right edge guide and slide the left edge guide over to the paper's left edge. Then turn the printer on.



When the  power and  paper out buttons *flash* and the  black and  color ink out lights *come on*, jammed paper may be blocking movement of the print head. Turn off the printer (press the  power button); wait 15 seconds; then turn it on again. If this does not clear the error, contact your dealer or EPSON as described in [Where To Get Help](#).

When all the lights flash, your printer may have an internal error. Turn off the printer (press the  power button); wait 15 seconds; then turn it on again. If this does not clear the error, contact your dealer or EPSON as described in [Where To Get Help](#).

When all the lights are *off*, the printer is not receiving power. Try these solutions:



- ▶ Make sure the printer is turned on.
- ▶ Turn off the printer, plug in the power cord securely, and turn on the printer.
- ▶ Make sure the outlet is not controlled by a switch or timer and is operable.

Running a Printer Check

You can run a printer check to determine whether the problem comes from the printer itself or some other source.

- ▶ If the results are satisfactory, the problem lies in software settings, the interface cable, or your computer.
- ▶ If the printer check does not print correctly, there is a problem with your printer. See the suggestions in this chapter for possible solutions.

Follow these steps to check the printer:

- 1 Make sure both the printer and computer are turned off.
- 2 Disconnect the interface cable from the printer.
- 3 Make sure paper is loaded in the printer.
- 4 Hold down the  load/eject button and press the  power button. Hold down the buttons until the  power light starts to flash. Then release both buttons.

The printer prints one page containing the printer's ROM version, ink counter code, and a nozzle check pattern. Only the nozzle check pattern is shown below:

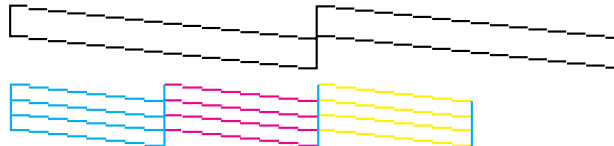



- 5 Turn off the printer. Then reconnect the interface cable and turn on your printer and computer.
- 6 Compare the quality of the printed nozzle check pattern with the sample above. In particular, look for missing segments in the lines, which may indicate a misaligned print head or clogged ink nozzle. See [Aligning the Print Head](#) or [Cleaning the Print Head](#) for instructions.

Improving Print Quality



You can often improve print quality by doing one of the following:

- ▶ Clean the print head; the print head nozzles may be clogged (see [Cleaning the Print Head](#) for instructions).
- ▶ Use higher quality paper appropriate for your print job (see [Selecting Special Media](#) for a list of EPSON papers).
- ▶ Match the Media Type setting in the printer settings dialog box to the type of media you loaded in the printer. Then the printer software can automatically select other settings for the best quality (see [Setting Printer Options from Windows Applications](#) and [Printing on Special Media](#) for details).
- ▶ Turn off **High Speed** mode (see [Customizing Print Quality and Special Effects](#) for details).
- ▶ Turn off **Economy** mode (see [Customizing Print Quality and Special Effects](#) for details).

- D Replace the ink cartridges. If an ink cartridge is low on ink (the  black or  color ink out light is flashing) or the ink cartridge is more than six months old, the cartridge should be replaced. See [Replacing an Ink Cartridge](#) for instructions.
- D If you have vertical misalignment, run the Print Head Alignment utility (see [Aligning the Print Head](#) for instructions) or turn off High Speed mode.

Try the solutions listed above before trying these solutions to specific print quality problems.

The printed image has horizontal banding

Possible cause	Solution
The Media Type setting doesn't match the loaded paper.	Make sure the Media Type setting matches the paper you're using. See Setting Printer Options from Windows Applications for instructions.
The printable side of the paper is face down.	Remove the paper and reload it with the printable side (whiter) face up. See Media Loading and Handling Guidelines for instructions.
The MicroWeave option is not set.	Turn on MicroWeave in the Advanced dialog box. See Customizing Print Quality and Special Effects for more information.
The print head nozzles are clogged.	Clean the print head. See Cleaning the Print Head for instructions.
The ink cartridges are low on ink.	Check the  black and  color ink out lights to see which cartridge you may need to replace. See Replacing an Ink Cartridge for instructions.



Possible cause	Solution
The Maximum Printable Area setting is turned on.	Select the Standard Printable Area setting to avoid banding in the expanded margin area. See Selecting Paper Size and Orientation Options for more information.
The paper thickness lever is in the + position.	Set the paper thickness lever to the 0 position and try printing again. See Media Loading and Handling Guidelines for details.

Vertical lines are misaligned or vertical banding appears



Possible cause	Solution
The print head nozzles are clogged.	Clean the print head. See Cleaning the Print Head for instructions.
The High Speed setting is turned on.	Turn off the High Speed setting if vertical lines are misaligned. See Customizing Print Quality and Special Effects for information.
The print head is misaligned.	Run the Print Head Alignment utility. See Aligning the Print Head for instructions.
The paper thickness lever is in the + position.	Set the paper thickness lever to the 0 position and try printing again. See Media Loading and Handling Guidelines for details.

The printed image has incorrect or missing colors

Possible cause	Solution
The Ink option is set to Black .	Change the Ink setting to Color . See Setting Printer Options from Windows Applications for instructions.
The Media Type setting doesn't match the loaded paper.	Make sure the Media Type setting matches the paper you're using. See Setting Printer Options from Windows Applications for instructions.
The printable side of the paper is face down.	Remove the paper and reload it with the printable side (whiter) face up. See Media Loading and Handling Guidelines for instructions.
The Halftoning and Color Adjustment Mode options are set incorrectly for your document type.	Use the correct settings for the project you're printing, following the instructions in Customizing Print Quality and Special Effects and Adjusting Color Settings .
The ICM (Windows 95 and 98) or sRGB (Windows 98) settings are incorrect for your document.	Use the Automatic mode setting or choose a different project type. See Advanced Printing for more information.
The print head nozzles are clogged.	Clean the print head. See Cleaning the Print Head for instructions.

Possible cause	Solution
The ink cartridges are low on ink or one or more ink colors are empty.	Check the  black and  color ink out lights to see which cartridge you may need to replace. See Replacing an Ink Cartridge for instructions.
The colors displayed on your monitor don't match the printed colors.	Because your monitor and printer use different technologies to represent colors, your printed colors cannot exactly match the colors you see on your monitor screen. Use the ICM (Windows 95 and 98) setting. See Using Custom Project Types for more information.
The color settings in your application software need adjustment.	You may be able to adjust various color settings in your application software. See your software documentation for more information.

The printed image is faint or has gaps

Possible cause	Solution
The print head nozzles are clogged.	Clean the print head. See Cleaning the Print Head for instructions.
The Media Type setting doesn't match the loaded paper.	Make sure the Media Type setting matches the paper you're using. See Setting Printer Options from Windows Applications for instructions.
The loaded paper is damaged, old, or dirty.	Remove the paper and reload a new stack with the printable side face up. See Media Loading and Handling Guidelines for instructions.
The ink cartridges are low on ink.	Check the  black and  color ink out lights to see which cartridge you may need to replace. See Replacing an Ink Cartridge for instructions.

Color documents print in black and white

Possible cause	Solution
Your printer is not selected in your application.	Select your printer and port in your software application.
Color printing is not selected.	Select color printing in your application and the printer software.

The printed image is blurry or smeared

Possible cause	Solution
The loaded paper is damaged, old, or dirty.	Remove the paper and reload a new stack with the printable side face up. See Media Loading and Handling Guidelines for instructions.
The printer's thickness lever is in the wrong position.	Set the thickness lever to the 0 position for most papers. Set it to the + position for thicker paper and envelopes.
The paper is damp or the printable side is face down.	Remove the paper and reload a new stack with the printable side face up. See Media Loading and Handling Guidelines for instructions.
You loaded special media without a support sheet.	Follow the special media loading instructions in Selecting Special Media and on the paper packaging for media that require support sheets. Also try loading your media one sheet at a time.
You tried to print on cardboard or other non-recommended media.	Make sure your paper or media meets the specifications listed in Paper . If your printouts are still blurry after you change paper, clean the print heads as described in Cleaning the Print Head .

Possible cause	Solution
The Media Type setting doesn't match the loaded paper.	Make sure the Media Type setting matches the paper you're using. See Setting Printer Options from Windows Applications for instructions.
Ink has leaked inside the printer.	Clean carefully inside the printer to remove spilled ink. See Cleaning the Printer for instructions.
You're using the MicroWeave and High Speed settings with a misaligned print head.	Turn off High Speed (see Customizing Print Quality and Special Effects). Then run the Print Head Alignment utility following the instructions in Aligning the Print Head .
The resolution of your image may be too low.	If a photographic image looks grainy or rough, try using the PhotoEnhance3 (PhotoEnhance on Windows 3.1) and Sharpness setting to improve the printed quality. See Adjusting Color Settings for details. You can also increase the image resolution using your image-editing software, or decrease the size of the image.

Solving Printing Problems

If the printer won't print, first check that:

- ▶ The printer is turned on and the ⏻ power light is on, but not flashing.
- ▶ Paper is loaded in the printer.
- ▶ The printer is plugged into a working electrical outlet that's not controlled by a switch or timer.
- ▶ The interface cable is securely connected to the printer and computer and both are turned on.

If you still can't print, check the following solutions.

All lights are off

Possible cause	Solution
The printer is not receiving power.	<p>Try these solutions:</p> <ul style="list-style-type: none">▶ Make sure the printer is turned on.▶ Turn off the power and plug in the power cord securely.▶ Make sure the outlet is not controlled by a switch or timer and is operable.▶ Try using another power outlet.



Only the power light is on, but nothing prints

Possible cause	Solution
The interface cable is not connected securely.	Turn off your printer and computer. Then make sure the cable is connected securely and meets the printer's specifications. (Use a fully shielded IEEE-1284 compliant parallel cable.)
The printer has an internal problem.	Turn off the printer and computer, disconnect the interface cable, and run a printer check as described in Running a Printer Check .
The printer software or application software is installed incorrectly.	If you ran a printer check successfully, make sure your printer and application software are installed correctly. If you're printing on a network, you may need to set up your printer for network printing, as described in Network Printing in Windows 95 and Windows 98 .
Your computer doesn't have enough memory to handle the data in the file you are printing.	Try one of the following: <ul style="list-style-type: none">▶ Reduce the resolution of your image.▶ Select fewer colors or a lower resolution for your monitor.▶ Add more memory to your computer.
Printing is stalled.	Delete the stalled print jobs in Spool Manager. For Windows 95 and 98, see Deleting a Stalled Print Job . For Windows 3.1, see Deleting a Stalled Print Job . For Windows NT 4.0, see Deleting a Stalled Print Job . You may also need to uninstall the EPSON Printer Port. Select Start, Programs, EPSON , then click EPSON Printer Port Uninstall and follow the on-screen instructions.

The printer sounds as though it is printing, but nothing prints

Possible cause	Solution
The print head nozzles are clogged or the ink cartridges are too old.	Clean the print head nozzles; see Cleaning the Print Head for instructions. If cleaning doesn't help, replace the cartridges. For instructions, see Replacing an Ink Cartridge .

The paper out light is flashing or on

Possible cause	Solution
If flashing, paper is jammed.	See Paper jams inside the printer .
If on, there is no paper in the sheet feeder or the paper is loaded incorrectly.	Load paper or remove the stack and reload it as described in the <i>Printer Basics</i> book or Media Loading and Handling Guidelines . Then press the  load/eject button to turn off the  paper out light and resume printing.

A black or color ink out light is flashing or on

Possible cause	Solution
If flashing, the ink supply is getting low.	You need to replace the indicated ink cartridge soon. Make sure you have a new cartridge, then see Replacing an Ink Cartridge for instructions.
If on, the ink cartridge is empty.	You must replace the indicated ink cartridge; see Replacing an Ink Cartridge for instructions.

The  power and  paper out lights are flashing and the  black and  color ink out lights are on

Possible cause	Solution
Jammed paper may be blocking movement of the print head.	Turn off the printer, wait a few seconds, and turn it back on to eject any paper. If no paper is ejected, turn off the printer, remove the jammed paper, and turn it on again. If the lights are still flashing and on, contact EPSON as described in Where To Get Help .

All the lights are flashing

Possible cause	Solution
You haven't removed all the packing material from the printer.	Remove the packing material, following the instructions on the <i>Unpacking Sheet</i> .
An internal error may have occurred.	Turn off your printer, wait a few seconds, and turn it on again. If the lights still flash or stay on, contact EPSON as described in Where To Get Help .

The printer has finished charging the ink cartridge, but the  power light is still flashing

Possible cause	Solution
The ink cartridge clamp isn't locked down.	Press down on the clamp to lock it into place.
Packing material remains in the printer.	Remove the packing material, following the instructions on the <i>Unpacking Sheet</i> .

Possible cause	Solution
The printer needs to initialize.	If the printer is not moving or making noise, but the light is still flashing after 5 minutes have passed, turn the printer off. If the light is still flashing when you turn it back on, contact your EPSON dealer or see Where To Get Help .
The printer may be receiving data from the computer.	Turn the printer and computer off. Disconnect the printer from the computer. Turn the printer on. If the light continues to flash for more than 5 minutes, contact your EPSON dealer or see Where To Get Help .

Solving Printer Software Problems

If you have trouble with your printer software, first check that your printer is selected as the default Windows printer.

If you still have problems with your printer software, check the following solutions. If you need to uninstall the printer software, see [Uninstalling Printer Software](#).

After you install your printer software, you see a New Hardware Found window

Possible cause	Solution
Windows has detected your printer.	Click Do not install a driver , and then click OK . Never select any other option on the New Hardware Found window.

The printer software installed with Windows 3.1 doesn't work correctly after you upgrade to Windows 95 or Windows 98

Possible cause	Solution
Your printer software is not set up correctly for the new operating system.	Uninstall the printer software after installing Windows 95 or Windows 98, as described in Uninstalling Printer Software . Then reinstall it as described in the <i>Start Here</i> card.

You see a spooling error message

Possible cause	Solution
Spooling error messages or very slow printing may be caused by temporary files (Windows 3.1 only).	Change the Spool Manager default spool directory, following the instructions in Changing the Default Spool Directory .
Your hard drive is too full.	Delete unnecessary files to make room on the drive.
Your computer doesn't have enough memory for the file you're printing.	Try one of the following: <ul style="list-style-type: none">▶ Reduce the resolution of your image.▶ Select fewer colors or a lower resolution for your monitor.▶ Add more memory to your computer.

The Status Monitor 2 window doesn't appear

Possible cause	Solution
Status Monitor 2 is not available in Windows 3.1	Upgrade to a newer operating system.
You did not restart your computer after installing Status Monitor 2.	Click Start , select Shut Down , click Restart the computer , and click Yes to restart your computer. Then try using Status Monitor 2.
Bi-directional support is not enabled.	Make sure your printer is connected to your computer with a bi-directional cable. Then click Start , select Settings , and click Printers . Right-click the EPSON Stylus COLOR 640 icon and select Properties . Click the Details tab, then click the Spool Settings button. Click the Enable bi-directional support for this printer radio button to turn on bi-directional support. Click OK twice, then close the Printers window and try printing again.
You're using ScanDisk.	Before using ScanDisk, turn off background monitoring in Status Monitor 2. (See Enabling Background Monitoring for instructions.) Then turn it back on when you're finished using ScanDisk.

After you install your printer software, you can't run ScanDisk (Windows 95)

Possible cause	Solution
You cannot use ScanDisk if Status Monitor 2 is active.	Disable Status Monitor 2 whenever you want to run ScanDisk. See Enabling Background Monitoring for details.

You cannot print on a Windows NT 4.0 network

Possible cause	Solution
Your printer is not set up correctly as a remote printer.	You may need to use a different network path and printer port. Select a different port in the printer's Properties windows and enter the new network path to your printer at the DOS prompt. Then restart your computer. See your Windows NT documentation for instructions on changing the printer port and network path.

Printing is too slow

Possible cause	Solution
Your printer software options are set incorrectly.	<p>For the fastest printing, try the following:</p> <ul style="list-style-type: none">▶ Set Print Quality to Economy.▶ Turn MicroWeave off.▶ Turn High Speed on.▶ Choose Black ink and No Halftoning. <p>See Basic Printing and Advanced Printing for more information.</p>
Your system doesn't have enough resources.	<ul style="list-style-type: none">▶ Clear space on your hard disk or run a defragmentation utility.▶ Don't run too many applications at the same time.▶ Turn off virtual memory.▶ Increase your system's memory (RAM).
You're not using ECP or Enhanced mode and/or DMA transfers.	If your computer supports ECP or Enhanced mode and/or DMA transfers, turn them on to speed up printing. See your computer documentation for details.

Fixing Paper Problems

To avoid most paper handling problems:

- ▶ Use smooth, high-quality media designed for ink jet printers that meets the media specifications in [Paper](#).
- ▶ Follow all loading and handling instructions included with the media.
- ▶ When loading multiple sheets, fan the stack of paper to make sure the sheets are not stuck together.
- ▶ Load the media with the printable side face up, as described in the *Printer Basics* book or in [Media Loading and Handling Guidelines](#).

If you have problems with paper feeding, paper jams, or ejected paper, check here for solutions.

Paper doesn't eject fully or is wrinkled

Possible cause	Solution
If the paper doesn't eject fully, you may have set the wrong paper size.	Press the  load/eject button to eject the paper. Then make sure you select the correct paper size in your application or printer software. (See Paper for the paper sizes you can print with.)
If it's wrinkled when it comes out, the paper may be damp or too thin.	See Paper for paper thicknesses you can print with, as well as environmental requirements for storage.

Paper doesn't feed

Try this	Then do this
Remove the stack of paper from the sheet feeder.	<p>Check that the paper:</p> <ul style="list-style-type: none">▶ Isn't curled or creased.▶ Isn't too old (see Media Loading and Handling Guidelines or your paper packaging for more information).▶ Isn't loaded above the arrow on the left edge guide.▶ Isn't jammed inside the printer. (If the  paper out light is flashing, paper is jammed.) <p>Then reload the paper as described in Media Loading and Handling Guidelines, making sure the left edge guide is adjusted to fit the paper's width.</p>

Paper jams inside the printer

Try this	Then do this
Turn off your printer, open the cover, and remove all the paper that's inside, including any small pieces that may have torn off.	<p>Reload the paper as described in the <i>Printer Basics</i> book and Printing on Special Media. If your paper jams frequently, make sure you:</p> <ul style="list-style-type: none">▶ Use smooth, high-quality paper, loaded printable side up.▶ Fan the stack and then even the edges before loading it.▶ Don't load paper above the arrow mark on the left edge guide.▶ Place the paper against the right edge guide and adjust the left edge guide to fit the width of your paper.

Multiple pages feed at the same time

Try this	Then do this
Remove the stack of paper from the printer.	<ul style="list-style-type: none">▶ Make sure the paper isn't too thin (see Paper).▶ Fan the edges of the stack of paper to separate the sheets.▶ Reload the paper as described in the <i>Printer Basics</i> book and in Media Loading and Handling Guidelines.▶ Make sure the paper edge guides are snug against the edge of the paper.▶ If too many copies of a page or document are printing, check the Copies settings in both the printer software and your application program. See Selecting Paper Size and Orientation Options for more information.

Solving Miscellaneous Printout Problems

If your printout results are not what you expected, try these solutions.

Characters are incorrect or garbled

Possible cause	Solution
Your printer is not selected in your application or as the Windows default printer.	Select your printer in your application or select it as the default Windows printer. See your Windows documentation or online help for instructions.
Printing is stalled.	Delete the stalled print jobs in Spool Manager. For Windows 95 and 98, see Deleting a Stalled Print Job . For Windows 3.1, see Deleting a Stalled Print Job . For Windows NT 4.0, see Deleting a Stalled Print Job . You may also need to uninstall the EPSON Printer Port. Select Start, Programs, EPSON , then click EPSON Printer Port Uninstall and follow the on-screen instructions.
The interface cable is not securely connected.	Turn off your printer and computer. Then make sure the cable is connected securely and meets the printer's specifications.

Possible cause	Solution
You're using a switch box with your printer.	Connect the printer directly to your computer and try printing again.
Your video driver may be conflicting with the EPSON printer driver.	Try using a standard VGA video driver (see your computer or video card documentation for instructions on changing video drivers). If your printout is correct, your video driver is interfering with the printer driver. Contact your computer or video card manufacturer to see if an updated driver is available.

The margins are incorrect

Possible cause	Solution
Margins are set incorrectly in your software application.	Check your software documentation for instructions on selecting the correct margins for your paper size. Make sure the margins are within the printable area of the page. See Printable area for more information.
Paper settings in the printer software are incorrect for your paper size.	Select the correct paper settings for your paper size. Make sure the Printable Area setting is correct for your project. See Printing on Special Media for more information.

The image size or position is incorrect

Possible cause	Solution
The paper and/or layout options are set incorrectly.	Check the paper settings and the settings in the Layout dialog box (Windows 95, 98, and NT only). See Selecting Print Layout Options for instructions. Also check the paper and layout settings in your application software.

The image is inverted, as if viewed in a mirror

Possible cause	Solution
You used a Flip Horizontal option.	Turn off the Flip Horizontal or mirror setting in your application software or the printer software. See Customizing Print Quality and Special Effects for information.

The printer prints blank pages

Possible cause	Solution
Your printer is not selected in your application or as the Windows default printer.	Select your printer as the default Windows printer. See your Windows documentation or Windows online help for instructions.
Paper settings in the printer software are incorrect for your paper size.	Select the correct paper settings for your paper size. See Printing on Special Media for more information.
The print head nozzles are clogged.	Clean the print head following the instructions in Cleaning the Print Head .

Uninstalling Printer Software



Caution:

If you uninstall and then reinstall the printer software in Windows 95, 98, or NT 4.0, you must also uninstall and then reinstall Status Monitor 2 so it can recognize your printer.

If any of the suggested solutions in this chapter tell you to uninstall and then reinstall your printer software, follow the steps in this section.

Windows 95, Windows 98, and Windows NT 4.0 Instructions

- 1 Double-click the **My Computer** icon, then double-click the **Control Panel** icon.
- 2 Double-click **Add/Remove Programs**.
- 3 To uninstall the printer software, select **EPSON Printer Software** in the program list. Click the **Add/Remove** button. Select the **EPSON Stylus COLOR 640** printer icon and click **OK**. Follow the instructions on the screen.
- 4 To uninstall Status Monitor 2, select **EPSON Status Monitor 2** in the program list. (Background monitoring must be turned off before removing Status Monitor 2.) Click the **Add/Remove** button. Follow the instructions on the screen.
- 5 Restart your computer.
- 6 To reinstall your software, see the *Start Here* card.

Windows 3.1 Instructions

- 1 Double-click the **Main** program group icon, then double-click the **Control Panel** icon.
- 2 Double-click **Printers**.
- 3 Select **EPSON Stylus COLOR 640** in the Installed Printers list and click the **Remove** button.
- 4 To reinstall your software, see the *Printer Basics* book.

Where To Get Help

EPSON provides technical assistance through electronic support services and automated telephone services 24 hours a day. The following tables list the contact information:

Electronic support services

Service	Access
World Wide Web	From the Internet, you can reach EPSON's Home Page at http://www.epson.com .
EPSON Internet FTP Site	If you have Internet FTP capability, use your Web browser (or other software for FTP downloading) to log onto ftp.epson.com with the user name anonymous and your e-mail address as the password.
EPSON Download Service	You can call the EPSON Download Service at (800) 442-2007 . Set your communications software to 8 data bits, 1 stop bit, no parity. Modem speed can be up to 28.8 Kbps.
EPSON Forum on CompuServe®	Members of CompuServe can type GO EPSON at the menu prompt to reach the Epson America Forum. For a free introductory CompuServe membership, call (800) 848-8199 and ask for representative #529.

Automated telephone services

Service	Access
EPSON SoundAdvice SM	For pre-recorded answers to commonly asked questions about EPSON products 24 hours a day, seven days a week, call (800) 442-2110 .
EPSON FaxAdvice TM	Access EPSON's technical information library by calling (800) 442-2110 . You must provide a return fax number to use this service.
EPSON Referral Service	For the location of your nearest Authorized EPSON Reseller or Customer Care Center, call (800) 442-2110 .



Note:
If you need help using another manufacturer's software with an EPSON product, see the documentation for that software for technical support information.

To speak to a technical support representative, dial (310) 974-4303 (U.S.) or (905) 709-2567 (Canada), 6 AM to 8 PM, Pacific Time, Monday through Friday and 7 AM to 4 PM, Saturday. Toll or long distance charges may apply.



Before you call, please have the following information ready:

- ▶ Product name
- ▶ Product serial number
- ▶ Computer configuration
- ▶ Description of the problem

You can purchase ink cartridges, paper, and manuals from EPSON Accessories at (800) 873-7766 (U.S. sales only). In Canada, please call (800) 873-7766 for dealer referral.

Specifications

Printing

Printing method	on-demand ink jet
Nozzle configuration	
Black	64 nozzles
Color	96 nozzles (32 each: cyan, magenta, yellow)
Resolution	Maximum 1440 dpi × 720 dpi
Print direction	Bidirectional with logic seeking
Control code	ESC/P Raster™, EPSON Remote
Input buffer	32KB
Character Tables	The character tables for PC437 (U.S., Standard Europe) and PC 850 (Multilingual) can be selected using the control panel buttons. Hold down the  cleaning button and then press the  power button to turn on the printer. Then release both buttons.

Paper

Paper type	Size	Description	Thickness	Weight
Single sheets	Letter (8.5 × 11 inches) Legal (8.5 × 14 inches) Half letter (statement; 5.5 × 8.5 inches) Executive (7.5 × 10 inches) A4 (210 × 297 mm) A5 (148 × 210 mm) B5 (182 × 257 mm)	Plain bond paper and special ink jet papers distributed by EPSON	0.003 to 0.004 inch (0.08 to 0.11 mm) for plain bond paper	17 to 24 lb (64 to 90 g/m ²) for plain bond paper
Transparencies, Glossy film, Glossy paper	Letter (8.5 × 11 inches) A4 (210 × 297 mm) A6 (105 × 148 mm, glossy film only)	Transparencies, glossy paper, and glossy film distributed by EPSON	—	—
Self adhesive sheets	A4 (210 × 297 mm)	Self adhesive sheets distributed by EPSON	—	—
Envelopes	No. 10 9.5 × 4.1 inches (240 × 104 mm) DL 8.7 × 4.3 inches (220 × 110 mm) C6 4.4 × 6.4 inches (114 × 162 mm) Ink jet note card 132 × 220 mm	Plain bond paper or air mail paper	0.006 to 0.02 inch (0.16 to 0.52 mm)	12 to 20 lb (45 to 75 g/m ²)

Paper type	Size	Description	Thickness	Weight
Index (ink jet) cards	A6 (105 × 148 mm) 8 × 10 inches (203 × 254 mm)	Ink jet cards distributed by EPSON	—	—
Photo paper	Letter (8.5 × 11 inches) A4 (210 × 297 mm) 4 × 6 inches (102 × 152 mm) Panoramic (210 × 594 mm)	Photo paper distributed by EPSON	—	—
Photo stickers	A6 (105 × 148 mm), 16 frames per page	Photo stickers distributed by EPSON	—	—
Iron-On Cool Peel transfer paper	Letter (8.5 × 11 inches)	Transfer paper distributed by EPSON	—	—



Note:

Since the quality of any particular brand or type of paper may be changed by the manufacturer at any time, EPSON cannot attest to the quality of any non-EPSON brand or type of paper. Always test samples of paper stock before purchasing large quantities or printing large jobs.

Poor quality paper may reduce print quality and cause paper jams and other problems. If you encounter problems, switch to a higher grade of paper.

Do not load curled or folded paper.

Special papers distributed by EPSON are only usable under these conditions:

Temperature: 59 to 77 °F (15 to 25 °C)

Humidity: 40 to 60% RH

Store EPSON Photo Quality Glossy Film and self adhesive sheets under the following conditions:

Temperature: 59 to 86 °F (15 to 30 °C)

Humidity: 20 to 60% RH

Printable area

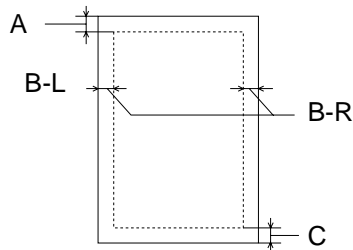

single sheets/index cards

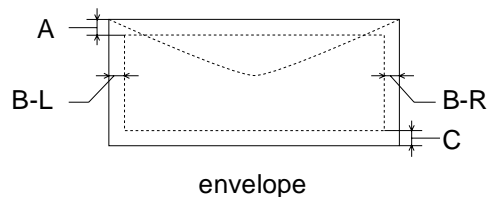

- A: The minimum top margin is 0.12 inch (3.0 mm).
When loading multiple sheets of EPSON Photo Quality Glossy Film, the minimum top margin is 1.2 inches (30 mm).
- B-L: The minimum left margin is 0.12 inch (3.0 mm).
- B-R: The minimum right margin is as follows:
0.35 (9.0 mm) for letter and legal size sheets
0.12 inch (3.0 mm) for other size sheets

0.28 inch (7.0 mm) for DL envelopes.
1.10 inches (28.0 mm) for No. 10 envelopes.
0.12 inch (3.0 mm) for C6 envelopes.
- C: The minimum bottom margin is 0.54 inch (14.0 mm).



Note:

Always load paper into the sheet feeder short edge first. However, envelopes should be loaded long edge first, with the flap side down.

You can extend the minimum bottom margin to 0.12 inch (3.0 mm) by selecting Maximum as the Printable Area Setting on the printer driver Paper menu. However, print quality may decline in the expanded area. Before printing large jobs, print a single sheet to confirm print quality.

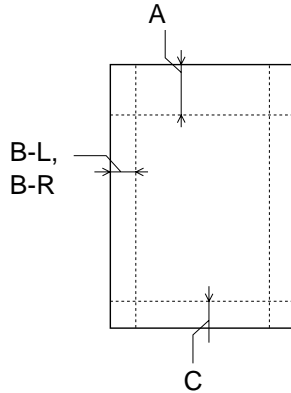

EPSON 4 × 6-inch Photo Paper
(dotted lines indicate perforations)

- A: The maximum top margin is 0.67 inch (17.0 mm).
- B-L,
B-R: The maximum left and right margin is 0.24 inch (6.1 mm).
- C: The maximum bottom margin is 0.24 inch (6.1 mm).

Ink Cartridge

Specification	Black ink cartridge (S020187)	Color ink cartridge (S020191)
Color(s)	Black	Cyan, Magenta, Yellow
Print capacity*	540 pages text (ISO/IEC 10561 letter pattern) 380 pages graphic (5% coverage)	300 pages (15% coverage)
Cartridge life	2 years from production date (if unopened) and within 6 months after opening package, at 77 °F (25 °C)	
Storage temperature	Installed: –4 to 104 °F (–20 to 40 °C) 1 month at 104 °F (40 °C) Uninstalled: –22 to 104 °F (–30 to 40 °C) 1 month at 104 °F (40 °C)	
Transit temperature	–22 to 140 °F (–30 to 60 °C) 1 month at 104 °F (40 °C) 120 hours at 140 °F (60 °C)	
Freezing temperature**	3.2 °F (–16 °C)	–0.4 °F (–18 °C)
Dimensions	0.7 (W) × 2.1 (D) × 1.5 (H) inches 19.8 (W) × 52.7 (D) × 38.5 (H) mm	1.7 (W) × 2.1 (D) × 1.5 (H) inches 42.9 (W) × 52.7 (D) × 38.5 (H) mm

* The print capacity may vary, depending on how often you clean the print head.

** Ink thaws and is usable after approximately 3 hours at 77 °F (25 °C).



Caution:

To ensure good results, use genuine EPSON cartridges and do not refill them. Other products may cause damage to your printer not covered by EPSON's warranty.

Mechanical

Paper feed method	Friction
Paper path	Sheet feeder, top entry, front out
Sheet feeder capacity	100 sheets at 17 lb (64 g/m ²) paper
Dimensions	
Storage	Width: 16.9 inches (429 mm) Depth: 9.1 inches (231 mm) Height: 6.1 inches (157 mm)
Printing	Width: 16.9 inches (429 mm) Depth: 23.7 inches (602 mm) Height: 11.6 inches (295 mm)
Weight	11.5 lb (5.2 kg) without the ink cartridges

Electrical

Specification	120 V Model	220–240 V Model
Input voltage range	99 to 132 V	198 to 264 V
Rated frequency range	50 to 60 Hz	
Input frequency range	49.5 to 60.5 Hz	
Rated current	0.4 A (max. 0.5 A)	0.2 A (max. 0.3 A)
Power consumption	Approx. 15 W (ISO/IEC 10561 Letter Pattern) Approx. 5 W in standby mode ENERGY STAR compliant	

This product is also designed for IT power system phase-to-phase voltage 220–240 V.



Note:

Check the label on the back of your printer for the printer's voltage.

Environmental

Temperature

Operation	50 to 95 °F (10 to 35 °C)
Storage	-4 to 104 °F (-20 to 40 °C) 1 month at 104 °F (40 °C)
Transit*	-4 to 140 °F (-20 to 60 °C) 120 hours at 140 °F (60 °C)

*Stored in shipping container

Humidity

Operation	20 to 80% RH, without condensation
Storage*	5 to 85% RH, without condensation

*Stored in shipping container

Safety Approvals

Safety standards	UL 1950, CSA C22.2 No. 950 with D3
EMC	FCC part 15 subpart B class B, CSA C108.8 class B

Parallel Interface

Your printer is equipped with an 8-bit parallel interface, with the following characteristics:

Forward channel

Data format: 8-bit parallel, IEEE-1284 compatibility mode

Synchronization: $\overline{\text{STROBE}}$ pulse

Handshake timing: BUSY and $\overline{\text{ACKNLG}}$ signals

Signal level: TTL compatible

Connector: 57-30360 Amphenol connector or equivalent

Reverse channel

Transmission mode: IEEE-1284 Nibble mode

Adaptable connector: 57-30360 Amphenol connector or equivalent

Synchronization: Refer to the IEEE-1284 specification

Handshaking: Refer to the IEEE-1284 specification

Signal level: IEEE-1284 Level 1 device, TTL compatible

Data transmission timing: Refer to the IEEE-1284 specification

Glossary

- banding** The horizontal lines that sometimes appear in a printed image. See also [MicroWeave](#).
- bidirectional** Moving the print head from left to right and right to left, for faster output.
- buffer** The portion of the printer's memory used to store data before printing it.
- character table** A collection of letters, numbers, and symbols that provides you with the characters used in a particular language.
- CMYK** Cyan (blue-green), magenta, yellow, and black. These colored inks are used to create printed colors.
- default** A value or setting that takes effect when the equipment is turned on, reset, or initialized.
- Despooler** An EPSON software program for Windows 3.1 that displays the status of your print jobs and allows you to manage them.
- dithering** A halftoning method in which dots are arranged in an orderly pattern. Dithering works best for printing images with solid colors, such as charts and graphs. See also [halftoning](#).

dpi	Dots per inch. The dpi measures the resolution. See also resolution .
driver	A software program that sends instructions to a computer device to tell it what to do. For example, your printer driver accepts print data from your image processing application and sends instructions to the printer on how to print this data.
Error Diffusion	This halftoning setting smooths out edges by randomly placing dots of varying colors. This has the opposite effect of the Finest Detail setting.
ESC/P Raster	A version of the ESC/P® (Epson Standard Code for Printers) command language, which gives you control of your printer from your computer. Commands in this language produce enhanced graphics printing.
Finest Detail	This setting automatically makes your printed images sharper and clearer. This has the opposite effect of the Error Diffusion setting. Be aware that this may increase the time required for printing.
font	A style of type designated by a name.
gamut	The range of colors that a device (such as a printer or monitor) can accurately reproduce.
grayscale	A scale of shades of gray from black to white. Grayscale is used to represent colors when printing with black ink only.

halftoning	A method of using dot patterns to represent an image. Halftoning makes it possible to produce varying shades of gray using only black dots, or a nearly infinite array of colors using only a few colors of dots.
host system	The computer connected directly to the printer in a network.
initialization	Process that returns the printer to its defaults (fixed set of conditions). This happens every time you turn on or reset the printer.
ink jet	A method of printing in which images, lines, letters, or symbols are formed by precisely spraying ink onto paper.
interface	The connection between the computer and a peripheral such as a printer. Your printer has a parallel interface that transmits data one byte, or eight bits, at a time.
media	Materials upon which data is printed, such as envelopes, plain paper, special paper, and transparencies.
Micro Piezo	Ink jet technology that uses an electronic pulse to precisely force the ink through the print head. This results in smaller, cleaner dots, sharp lines, and crisp text.
MicroWeave	Printing technology that produces images in fine increments to reduce the possibility of banding. See also banding .
parallel interface	See interface .

print queue Print jobs that are sent to the printer while it is busy are stored in a waiting line, or print queue, until they can be printed.

print server The computer connected to the printer. It receives the jobs and then distributes them to the assigned printer. It also holds extra print jobs while the printer is busy. See also [print queue](#).

printable area The area of a page on which the printer can print. It is smaller than the physical size of the page due to margins.

printer driver See [driver](#).

Progress Meter An EPSON software program that shows the progress of the current print job. It appears each time you send a print job, unless you turn it off.

RAM Random Access Memory. The area of your computer's memory that runs programs and stores data.

reset To return a printer to its defaults either by sending a command or an INIT signal, or by turning the printer off and then back on.

resolution The number of dots per inch used to represent an image.

ROM Read Only Memory. Memory area in your printer or computer that cannot be modified. ROM retains its contents when you turn off the printer or computer.

saturation The depth or vibrancy of a color; the amount of gray.

spool The process by which the printer driver converts the print data into codes that your printer understands. This data is then sent to the printer directly or to the print server.

Spool Manager An EPSON software program for Windows 3.1 that displays a list of EPSON Stylus printer queues and allows you to manage the queues and print jobs.

Status Monitor 2 An EPSON software program for Windows 95, 98, and NT that displays the printer's status, such as paper out or the amount of ink remaining before printing.

Index

A

- Accessories, [62](#) to [63](#), [104](#), [143](#)
- Advanced mode, selecting, [26](#) to [28](#)
- Advanced settings
 - color, [32](#) to [39](#)
 - enlarging documents, [47](#) to [50](#)
 - layout, [46](#) to [56](#)
 - orientation, [39](#) to [43](#)
 - paper size, [39](#) to [46](#)
 - predefined custom projects, [26](#) to [28](#)
 - print quality, [29](#) to [31](#)
 - reducing documents, [47](#) to [50](#)
 - saving custom, [57](#) to [60](#)
 - special effects, [29](#) to [31](#)
 - watermarks, [52](#) to [56](#)
- Aligning print head, [110](#), [120](#) to [121](#)
- Automatic color adjustment setting, [36](#)
- Automatic mode, [18](#)

B

- Background monitoring
 - Windows 3.1, [92](#) to [95](#)
 - Windows 95, 98, and NT 4.0, [82](#) to [91](#)
- Banding, [120](#) to [121](#)
- Basic printing, [15](#) to [24](#)

- Bitmap files, [55](#)
- Blank pages, [139](#)
- Blurry printouts, [124](#) to [125](#)
- Brightness setting, [37](#)

C

- Cancelling print jobs, [23](#) to [24](#), [81](#), [91](#) to [95](#)
- Cards, see Photo Quality Ink Jet and Note Cards
- Characters, garbled, [137](#) to [138](#)
- Cleaning
 - print head, [99](#) to [103](#)
 - printer, [111](#)
- Cleaning sheets, [64](#), [99](#)
- Collate setting, [42](#)
- Color
 - correction, [38](#) to [39](#)
 - customizing, [32](#) to [39](#)
 - problems, [122](#) to [124](#)
- Color Adjustment modes, [36](#)
- CompuServe, [142](#)
- Contrast setting, [37](#)
- Control code, [144](#)
- Control panel, [102](#) to [103](#), [116](#) to [117](#), [126](#) to [130](#)

Custom settings
color, [32](#) to [39](#)
deleting, [60](#)
layout, [46](#) to [56](#)
list, [27](#)
orientation, [39](#) to [43](#)
paper size, [39](#) to [46](#)
predefined project types, [26](#) to [28](#)
print quality, [29](#) to [31](#)
redefining, [59](#)
saving, [57](#) to [60](#)
special effects, [29](#) to [31](#)
Cyan setting, [37](#)

D Default printer options, setting, [20](#) to [22](#)
Deleting print jobs
troubleshooting, [127](#), [137](#)
Windows 3.1, [94](#)
Windows 95, 98, and NT 4.0, [82](#)
Despooler, [24](#), [92](#)
Diagnosing problems, [115](#) to [119](#)
Digital Camera Correction setting, [34](#)
Digital Camera setting, [27](#)
Dithering, [30](#)
DMA transfer, [80](#)
Documentation, how to use, [10](#) to [11](#)

E Economy setting, [27](#), [30](#), [119](#)
Electrical specifications, [152](#)
ENERGY STAR, [11](#)
Enlarging documents, [47](#) to [50](#)
Envelopes
printing on, [67](#)
specifications, [145](#) to [148](#)
Environmental specifications, [153](#)
EPSON
Accessories, [104](#), [143](#)
help, [142](#) to [143](#)
media, [62](#) to [63](#)
EPSON Printer Port option, [80](#)
Error Diffusion setting, [30](#)
Error message, spooling, [131](#)
ESC/P Raster control code, [144](#)

F Faint printouts, [123](#) to [125](#)
Film, *see* Photo Quality glossy media
Fine - 720 dpi setting, [30](#)
Finest Detail setting, [31](#)
Fit to Page setting, [50](#)
Flip Horizontal setting, [31](#), [75](#), [139](#)
Forms, loading, [66](#)

G Garbled characters, [137](#) to [138](#)
Glossy media, *see* Photo Quality glossy media

H Halftoning setting, [30](#)
Hard tone setting, [34](#)
Head Cleaning utility, [100](#) to [102](#)
Help, EPSON, [142](#) to [143](#)
Help, online, [18](#), [115](#)
High Speed Copies option, [80](#)
High Speed setting, [31](#), [119](#)
Horizontal banding, [120](#)

I ICM (Image Color Matching) setting, [28](#), [39](#), [123](#)
Index cards, *see* Photo Quality Ink Jet and Note Cards
Ink cartridge
 outdated, [108](#) to [109](#), [120](#)
 replacing, [104](#) to [109](#), [120](#)
 specifications, [150](#)
Ink jet cards, *see* Photo Quality Ink Jet and Note Cards
Ink Jet Paper
 choosing, [62](#)
 printing on, [68](#)
 specifications, [145](#) to [148](#)
Ink Jet Transparencies, *see* Transparencies
Ink level, [23](#) to [24](#), [90](#), [116](#), [128](#)
Ink setting, [18](#), [27](#), [30](#), [122](#)
Interface specifications, [154](#)

Iron-On Cool Peel Transfer Paper
 choosing, [62](#)
 printing on, [75](#)
 specifications, [146](#) to [148](#)

J Jammed paper, [117](#), [135](#)
Job Status window, [91](#)

L Landscape setting, [42](#)
Layout
 options, setting, [46](#) to [56](#)
 problems, [138](#)
 tab, [19](#), [49](#)
Letterhead, printing on, [66](#)
Lever, thickness, [65](#), [67](#)
Lights, [116](#) to [117](#), [126](#) to [130](#)

M Magenta setting, [37](#)
Main printer software settings, [17](#) to [22](#)
Maintaining printer, [98](#) to [111](#)
Managing print jobs
 Windows 3.1, [92](#) to [95](#)
 Windows 95, 98, and NT 4.0, [77](#) to [91](#)
Manuals, how to use, [10](#) to [11](#)
Margins
 incorrect, [138](#)
 with multiple sheets, [69](#), [74](#)

Maximum printable area setting, [43](#),
[69](#), [148](#)
Mechanical specifications, [151](#)
Media Type setting, [18](#), [30](#), [62](#) to [63](#),
[68](#) to [73](#)
Media, ordering, [62](#) to [63](#)
MicroWeave setting, [31](#)
Mirror images, [75](#), [139](#)
Monitoring
 ink level, [23](#) to [24](#), [90](#), [116](#)
 preferences, [84](#) to [85](#)
 print job, *see* Background
 monitoring
More Settings dialog box, [29](#) to [39](#)
Moving printer, [112](#)
Multiple print layouts, [51](#) to [52](#)

N

Network printing
 Windows 95 and 98, [95](#) to [97](#)
 Windows NT 4.0, [95](#)
No Color Adjustment setting, [36](#)
Normal - 360 dpi setting, [30](#)
Normal tone setting, [34](#)
Note cards, *see* Photo Quality Ink Jet
 and Note Cards
Nozzle Check
 pattern, [103](#), [118](#)
 utility, [102](#) to [103](#)

O

Ordering
 ink cartridges, [104](#)
 media, [62](#) to [63](#)
Orientation options, [39](#) to [43](#)
Outdated ink cartridge, [108](#) to [109](#)

P

Page frames, [51](#) to [52](#)
Page Order options, [51](#)
Panoramic Photo Paper, *see* Photo
 Paper
Paper
 glossy, *see* Photo Quality glossy
 media
 handling problems, [134](#) to [136](#)
 jams, [117](#), [135](#)
 ordering, [62](#) to [63](#)
 photo, *see* Photo Paper
 specifications, [145](#) to [149](#)
 support extension, [66](#), [71](#)
 tab, [19](#), [40](#), [44](#)
 thickness lever, [65](#), [67](#)
 types, settings, [18](#)
Paper Size options, [39](#) to [46](#)
Parts of printer, [114](#)
Photo Paper
 choosing, [63](#)
 printing on, [70](#) to [73](#)
 specifications, [146](#) to [147](#)

Photo Quality glossy media
choosing, [63](#)
printing on, [69](#)
specifications, [145](#) to [148](#)

Photo Quality Ink Jet and Note Cards
choosing, [62](#)
printing on, [68](#)
specifications, [146](#) to [148](#)

Photo Quality Ink Jet media
choosing, [62](#)
printing on, [70](#)
specifications, [146](#) to [148](#)

Photo Quality Self Adhesive Sheets
choosing, [62](#)
printing on, [74](#)
specifications, [145](#) to [148](#)

Photo Stickers
choosing, [63](#)
printing on, [74](#)
specifications, [146](#) to [148](#)

PhotoEnhance3 (PhotoEnhance)
setting, [27](#)

Photo-realistic color adjustment
setting, [36](#)

Portrait setting, [42](#)

Preprinted forms, loading, [66](#)

Print head
aligning, [110](#), [120](#) to [121](#)
cleaning, [99](#) to [103](#)

Print jobs, cancelling, [23](#) to [24](#), [81](#),
[91](#) to [95](#)

Print jobs, managing
Windows 3.1, [92](#) to [95](#)
Windows 95, 98, and NT 4.0,
[77](#) to [91](#)

Print layouts, multiple, [51](#) to [52](#)

Print quality
customizing, [29](#) to [31](#)
problems, [119](#) to [125](#)

Printable area
setting, [43](#), [73](#), [138](#)
specifications, [73](#), [148](#)

Printer
check, [118](#) to [119](#)
cleaning, [111](#)
moving, [112](#)
parts, [114](#)

Printer Information tab, [90](#)

Printer software
accessing, [20](#) to [22](#)
problems, [130](#) to [133](#)
uninstalling, [140](#) to [141](#)

Printer status
checking, [23](#) to [24](#)
window, [87](#) to [90](#)

Printing specifications, [144](#)

Problems

color, [122](#) to [124](#)
diagnosing, [115](#) to [119](#)
paper handling, [134](#) to [136](#)
print quality, [119](#) to [125](#)
printer software, [130](#) to [133](#)
printing, [126](#) to [130](#)
slow printing, [133](#)
solving, [113](#) to [139](#)
Status Monitor 2, [132](#)
unexpected printout results,
[137](#) to [139](#)

Progress Meter, [23](#), [77](#) to [80](#)

Project types, custom, [26](#) to [28](#)

Proportional Printing option, [41](#),
[47](#) to [50](#)

Q

Quality/Speed setting, [18](#)

R

ReadMe files, [115](#)

Reduce/Enlarge options, [50](#)

Reducing documents, [47](#) to [50](#)

Replacing, [104](#)

Replacing ink cartridges, [104](#) to [109](#)

Resolution, see Print quality

Reverse order printing, [42](#)

Rotate by 180° setting, [42](#)

S

Safety

approvals, [153](#)

instructions, [12](#) to [14](#)

Saturation setting, [37](#)

ScanDisk, [83](#), [132](#)

Self Adhesive Sheets, see Photo
Quality Self Adhesive Sheets

Self test, [118](#) to [119](#)

Sepia tone setting, [34](#)

Service, [142](#) to [143](#)

Sharpness setting, [34](#)

Slow printing, [133](#)

Smears, [65](#), [124](#) to [125](#)

Special effects, [29](#) to [31](#)

Specifications

electrical, [152](#)

environmental, [153](#)

ink cartridge, [150](#)

interface, [154](#)

mechanical, [151](#)

paper, [145](#) to [149](#)

printing, [144](#)

safety approvals, [153](#)

Speed & Progress options, [77](#) to [80](#)

Spool directory, [94](#)

Spool Manager

problems, [127](#), [131](#), [137](#)

Windows 3.1, [92](#) to [95](#)

Windows 95 and 98, [81](#) to [82](#)

sRGB (Standard Red Green Blue) setting, [28](#), [39](#)
Standard printable area setting, [43](#)
Status Alert dialog box, [84](#) to [85](#)
Status Monitor 2
 problems, [132](#)
 uninstalling, [140](#)
 using, [23](#), [82](#) to [91](#)
SuperFine - 1440 setting, [30](#)
Support, [142](#) to [143](#)
System requirements, [9](#)

T Technical support, [142](#) to [143](#)
Testing printer, [118](#) to [119](#)
Text/Graph setting, [27](#)
Thickness lever, [65](#), [67](#)
Tone setting, [34](#)
Transfer, [62](#)
Transparencies
 choosing, [63](#)
 printing on, [74](#)
 specifications, [145](#) to [148](#)
Transporting printer, [112](#)
Troubleshooting, [113](#) to [139](#)

U Uninstalling printer software
 Windows 3.1, [141](#)
 Windows 95, 98, and NT 4.0, [140](#)
User Defined paper size, [43](#) to [46](#)

Utilities
 Head Cleaning, [100](#) to [102](#)
 Nozzle Check, [102](#) to [103](#)
 Print Head Alignment, [110](#)
 Status Monitor 2, [23](#), [82](#) to [91](#),
 [132](#)

V Vertical banding, [121](#)
Vivid color adjustment setting, [36](#)

W Watermarks, [52](#) to [56](#)
Windows 3.1
 managing print jobs, [92](#) to [95](#)
 printer status, checking, [24](#)
 printing from, [16](#) to [19](#)
 Spool Manager, [92](#) to [95](#)
 uninstalling printer software, [141](#)
Windows 95 and 98, network
 printing, [95](#) to [97](#)
Windows 95, 98, and NT 4.0
 managing print jobs, [77](#) to [91](#)
 printer status, checking, [23](#) to [24](#)
 printing from, [16](#) to [19](#)
 Spool Manager, [81](#) to [82](#)
 uninstalling printer software, [140](#)
World Wide Web, [142](#)

Y Year 2000, [12](#)
Yellow setting, [37](#)